



BC77Q

**Intel® Socket LGA1155
3rd/ 2nd Generation Core i7/i5/i3 CPU**

ATX Motherboard

User's Manual

Edition 1.00 – Oct, 2012

FCC Statement



THIS DEVICE SUPPORTS PART 15 FCC RULES. OPERATION IS SUBJECT TO THE FOLLOWING TWO CONDITIONS:

(1) THIS DEVICE MAY NOT CAUSE HARMFUL INTERFERENCE.

(2) THIS DEVICE MUST ACCEPT ANY INTERFERENCE RECEIVED INCLUDING INTERFERENCE THAT MAY CAUSE UNDESIRE OPERATION.

THIS EQUIPMENT HAS BEEN TESTED AND FOUND TO COMPLY WITH THE LIMITS FOR A CLASS "A" DIGITAL DEVICE, PURSUANT TO PART 15 OF THE FCC RULES.

THESE LIMITS ARE DESIGNED TO PROVIDE REASONABLE PROTECTION AGAINST HARMFUL INTERFERENCE WHEN THE EQUIPMENT IS OPERATED IN A COMMERCIAL ENVIRONMENT. THIS EQUIPMENT GENERATES, USES, AND CAN RADIATE RADIO FREQUENCY ENERGY AND, IF NOT INSTALLED AND USED IN ACCORDANCE WITH THE INSTRUCTION MANUAL, MAY CAUSE HARMFUL INTERFERENCE TO RADIO COMMUNICATIONS.

OPERATION OF THIS EQUIPMENT IN A RESIDENTIAL AREA IS LIKELY TO CAUSE HARMFUL INTERFERENCE IN WHICH CASE THE USER WILL BE REQUIRED TO CORRECT THE INTERFERENCE AT HIS OWN EXPENSE.

Notice

This guide is designed for experienced users to setup the system within the shortest time. For detailed information, please always refer to the electronic user's manual.

Copyright Notice

Copyright © 2011 BCM Advanced Research, ALL RIGHTS RESERVED.

No part of this document may be reproduced, copied, translated, or transmitted in any form or by any means, electronic or mechanical, for any purpose, without the prior written permission of the original manufacturer.

Trademark Acknowledgement

Brand and product names are trademarks or registered trademarks of their respective owners.

Disclaimer

BCM Advanced Research reserves the right to make changes, without notice, to any product, including circuits and/or software described or contained in this manual in order to improve design and/or performance. BCM Advanced Research assumes no responsibility or liability for the use of the described product(s), conveys no license or title under any patent, copyright, or masks work rights to these products, and makes no representations or warranties that these products are free from patent, copyright, or mask work right infringement, unless otherwise specified. Applications that are described in this manual are for illustration purposes only. BCM Advanced Research makes no representation or warranty that such application will be suitable for the specified use without further testing or modification.

Life Support Policy

BCM Advanced Research PRODUCTS ARE NOT FOR USE AS CRITICAL COMPONENTS IN LIFE SUPPORT DEVICES OR SYSTEMS WITHOUT THE PRIOR WRITTEN APPROVAL OF BCM Advanced Research.

As used herein:

1. Life support devices or systems are devices or systems which, (a) are intended for surgical implant into body, or (b) support or sustain life and whose failure to perform, when properly used in accordance with instructions for use provided in the labeling, can be reasonably expected to result in significant injury to the user.
2. A critical component is any component of a life support device or system whose failure to perform can be reasonably expected to cause the failure of the life support device or system, or to affect its safety or effectiveness.

A Message to the Customer

BCM Customer Services

Each and every BCM product is built to the most exacting specifications to ensure reliable performance in the harsh and demanding conditions typical of industrial environments. Whether your new BCM device is destined for the laboratory or the factory floor, you can be assured that your product will provide the reliability and ease of operation for which the name BCM has come to be known.

Your satisfaction is our primary concern. Here is a guide to BCM customer services. To ensure you get the full benefit of our services, please follow the instructions below carefully.

Technical Support

We want you to get the maximum performance from your products. So if you run into technical difficulties, we are here to help. For the most frequently asked questions, you can easily find answers in your product documentation. These answers are normally a lot more detailed than the ones we can give over the phone. So please consult the user's manual first.

To receive the latest version of the user's manual; please visit our Web site at:

<http://www.bcmcom.com>.

If you still cannot find the answer, gather all the information or questions that apply to your problem, and with the product close at hand, call your dealer. Our dealers are well trained and ready to give you the support you need to get the most from your BCM products. In fact, most problems reported are minor and are able to be easily solved over the phone.

In addition, free technical support is available from BCM engineers every business day. We are always ready to give advice on application requirements or specific information on the installation and operation of any of our products. Please do not hesitate to call or e-mail us.

BCM Advanced Research

11 Chrysler,
Irvine, California, 92618
USA

Tel : +1-949-470-1888

Fax : +1-949-470-0971

<http://www.bcmcom.com>

E-mail: support@bcmcom.com

Product Warranty

BCM warrants to you, the original purchaser, that each of its products will be free from defects in materials and workmanship for two years from the date of purchase.

This warranty does not apply to any products which have been repaired or altered by persons other than repair personnel authorized by BCM, or which have been subject to misuse, abuse, accident or improper installation. BCM assumes no liability under the terms of this warranty as a consequence of such events. Because of BCM high quality-control standards and rigorous testing, most of our customers never need to use our repair service. If any of BCM products is defective, it will be repaired or replaced at no charge during the warranty period. For out-of-warranty repairs, you will be billed according to the cost of replacement materials, service time, and freight. Please consult your dealer for more details. If you think you have a defective product, follow these steps:

1. Collect all the information about the problem encountered. (For example, CPU type and speed, BCM products model name, hardware & BIOS revision number, other hardware and software used, etc.) Note anything abnormal and list any on-screen messages you get when the problem occurs.
2. Call your dealer and describe the problem. Please have your manual, product, and any helpful information available.
3. If your product is diagnosed as defective, obtain an RMA (return material authorization) number from your dealer. This allows us to process your good return more quickly.
4. Carefully pack the defective product, a complete Repair and Replacement Order Card and a photocopy proof of purchase date (such as your sales receipt) in a shippable container. A product returned without proof of the purchase date is not eligible for warranty service.

Write the RMA number visibly on the outside of the package and ship it prepaid to your dealer.

Manual Objectives

This manual describes in detail the BCM BC77Q Main board.

We strongly recommend that you study this manual carefully before attempting to interface with BC77Q or change the standard configurations. Whilst all the necessary information is available in this manual we would recommend that unless you are confident, you contact your supplier for guidance.

Please be aware that it is possible to create configurations within the CMOS RAM that make booting impossible. If this should happen, clear the CMOS settings, (see the description of the Jumper Settings for details).

If you have any suggestions or find any errors concerning this manual and want to inform us of these, please contact our Customer Service department with the relevant details.

Safety Precautions

Warning!



Always completely disconnect the power cord from your chassis whenever you work with the hardware. Do not make connections while the power is on. Sensitive electronic components can be damaged by sudden power surges. Only experienced electronics personnel should open the PC chassis.

Caution!



Always ground yourself to remove any static charge before touching the mainboard. Modern electronic devices are very sensitive to static electric charges. As a safety precaution, use a grounding wrist strap at all times. Place all electronic components in a static-dissipative surface or static-shielded bag when they are not in the chassis.

Document Amendment History

Revision	Date	Comment
1 st (1.00)	Oct, 2012	Initial Release

Contents

Chapter 1: System Setup	12
1.1 Welcome!	12
1.2 Packing Contents	12
1.3 Special Features	13
1.3.1 Product Highlights	13
1.4 Before you proceed	14
1.5 Mainboard Overview	15
1.5.1 Placement Direction	15
1.5.2 Mounting Holes	16
1.5.3 Onboard LEDs	17
1.5.4 Mainboard Layout	18
1.5.5 Layout Content List	19
1.5.5.1 Slots	19
1.5.5.2 Internal Jumpers	19
1.5.5.3 Internal Headers	20
1.5.5.4 Back Panel Connectors	21
1.6 Central Processing Unit (CPU)	22
1.6.1 Installing the CPU	23
1.6.2 Installing the CPU Heatsink and Fan	27
1.6.3 Uninstalling the CPU Heatsink and Fan	29
1.7 System Memory	31
1.7.1 Overview	31
1.7.2 Configurations of Supported Memory Modules (Non-Ecc, Unbuffered)	32
1.7.3 Dual-Channel Mode Population Rule	33
1.7.4 Installing DIMM	34
1.7.5 Removing a DIMM	36
1.8 Power Supply	37
1.8.1 ATX Power Connectors: EATXPWR1, ATX12V1	37
1.9 Back Panel	38
1.9.1 Back Panel Connectors	38
1.10 Connectors/Headers	39
1.10.1 Serial ATA Connectors: SATA3.0: SATA1, SATA2 SATA2.0: SATA3, SATA4, SATA5, SATA6	40
1.10.2 Fan Power Connectors: CPU_FAN1, CHA_FAN1, SYS_FAN1	41

1.10.3	Chassis Intrusion Switch Connector: JCASE1	42
1.10.4	Front Panel Audio Connector: FPAUD1.....	43
1.10.5	Amplifier Connector: JAMP1.....	44
1.10.6	Front USB2.0 Headers: USB45, USB67, USB89, USB1011, USB1213	44
1.10.7	Serial Port Connectors: COM1, COM2, COM3, COM4.....	45
1.10.8	LPT Port Connector: LPT1.....	45
1.10.9	Front Panel Connectors: F_PANEL.....	46
1.10.10	LANLED Header: LANLED1	46
1.10.11	Digital I/O Connector: DIO	47
1.10.12	RAID LED Header: SGPIO1	47
1.10.13	The Header: SPI_CN	47
1.11	Jumpers	48
1.11.1	Clear CMOS Jumper: CLRRTC1.....	48
1.11.2	COM1 RS232/RS422/RS485 Select: JP1, JP2, JP3.....	48
1.11.3	COM Port Ring-in/+12V/+5V Power Select: JCOMPWR1, JCOMPWR2, JCOMPWR3, JCOMPWR4.....	49
1.11.4	ATX/AT Mode Selection: PSON1	49
1.12	The Expansion Slots	50
1.12.1	Installation of Expansion Card	50
1.12.2	Setup An Expansion Card.....	50
1.12.3	PCI (Peripheral Component Interconnect) Express Slot	50
1.12.3.1	PCI-Ex16 Slot: PCIEX16.....	51
1.12.3.2	PCI-Ex4 Slot: PCIEX4_1.....	51
1.12.3.3	PCI-E x1 Slot: PCIEX1_1, PCIEX1_2.....	51
1.12.3.4	PCI Slots: PCI1, PCI2, PCI3.....	51
Chapter 2: Starting Up the System		52
2.1	Starting Up Your System.....	52
Chapter 3: BIOS Setup		54
3.1	Introducing BIOS.....	54
3.2	Entering BIOS Setup Menu.....	55
3.3	Getting Help	55
3.4	BIOS Menu Screen	56
3.5	Main Menu	57
3.6	Advanced Menu	58
3.6.1	PCI Subsystem Setting.....	59
3.6.2	ACPI Settings.....	60

3.6.3	Trust Computing	62
3.6.4	CPU Configuration	63
3.6.5	SATA Configuration	64
3.6.6	PCH-FW Configuration	65
3.6.7	AMT Configuration	66
3.6.8	USB Configuration	67
3.6.9	Second Super IO Configuration	68
3.6.9.1	Serial Port 1 Configuration	69
3.6.9.2	Serial Port 2 Configuration	70
3.6.9.3	Serial Port 3 Configuration	71
3.6.9.4	Serial Port 4 Configuraiton	72
3.6.10	Parallel Port Configuration	73
3.6.11	Hardware Monitor	75
3.6.11.1	Smart Fan	76
3.6.11.2	Smart Fan Mode Configuration	77
3.6.12	Option ROM Policy	79
3.6.13	CPU PPM Configuration	80
3.7	Chipset	82
3.7.1	PCH-IO Configuration	83
3.7.2	USB Configuration	85
3.8	System Agent (SA) Configuration	86
3.8.1	Graphics Configuration	87
3.8.2	PCIe Configuration	89
3.9	Boot	90
3.9.1	UEFI Boot Drive BBS Priorities	91
3.10	Security	92
3.11	Save & Exit	93

Mainboard Specifications

Model	BC77Q
Processor	Socket LGA1155 supports 3 rd / 2 nd Generation Core i7/i5/i3 CPU
Chipset	Intel® Q77
Memory	4 x 240 Pin DIMM sockets supports DDR3 memory module (1.5V) 1066/ 1333/ 1600 MHz up to 32GB (8GB maximum/slot) (1600MHz memory module only works with 3rd generation Intel Core i7/i5/i3 CPUs)
Display	Intel® GMA HD (Needs to use Intel Processor that provides “Intel HD Graphics” feature)
SATA	4 x SATA II connectors/ 2 x SATA III connectors
PCI-E	1x PCI-E x 16 slots (Slot “PCIEX16”)
	1 x PCI-E x4 slot (Slot “PCIEX4_1”)
	2 x PCI-E x1 Slots (Slot “PCIEX1_1”, “PCIEX1_2”)
PCI	3 x PCI Slots (PCI 2.3 compliant)
USB	10 x USB 2.0 ports (5 x header) 4 x USB3.0 ports (4x rear I/O)
TPM	Infineon® TPM Chip 9635 1 x TPM 1.2 Security Device
Super I/O Controller	Nuvoton® NCT6776F
Serial Ports	4 x RS232 ports (4 x header)
LPT	1 x LPT header
Watch Dog Timer	1 ~ 255 sec timer
HW Monitor	Yes
Audio	Realtek® ALC892 HD Audio Codec with auto jack sensing
LAN	Intel® 82579LM Gigabit PHY 1 x 10/100/1000 LAN Intel® 82583V PCI-E Gigabit LAN 1 x 10/100/1000 LAN
BIOS	AMI® BIOS AMI BIOS with 32Mb SPI ROM
Expansion Slots	
PCI-E	1 x PCI-E x 16 slot

	1 x PCI-E x 4 slot 2 x PCI-E x 1 slot
PCI	3 x PCI slot
Onboard I/O Headers	
SATA	6 x Std. SATA Connectors
USB	5 x USB Headers (10 ports on headers)
RS232	4 x Headers
LPT	1 x Header
Front Audio	1 x Header
Amplifier	1 x Header
Front Panel	1 x Header
Fan Header	3 x Headers (4-pins)
Chassis Intrusion Header	1 x Header
LANLED	1 x Header
Digital IO	1 x Header
SGPIO1 (RAID LED)	1 x Header
Onboard Jumpers	
COM Port Ring-In/ Power Select	4 x Headers provide selections of "Ring-In", or "12V" or "5V" on COM ports
COM1 RS232/RS422/RS485 Select	3 x Headers provide selections of "RS232", or "RS422", or "RS485" on COM1
AT/ATX Select	1 x Header
Clear CMOS	1 x Header
Back I/O Panel	
PS/2 Keyboard /Mouse	1 x DIN 6 Stack up Connector
VGA	1 x DB 15 Connector
DVI	1 x DVI Connector
Displayport	2 x Displayport Connectors
USB3.0	4x Stack up USB Connector
LAN and USB	2 x Stack up RJ45 with USB Connectors
Audio	1 x 3 Jacks Audio Connector (Line-in, Line-Out, Mic)
Power & Connector	
	1 x Std. 24 pin ATX Connector
	1 x 4 pin ATX 12 Connector
Form Factor	
	ATX 9.6" x 12.0"

Chapter 1: System Setup

This chapter describes the mainboard features and the new technologies it supports

1.1 Welcome!

The mainboard delivers a host of new features and latest technologies, making it another line of BCM long life mainboards! Before you start installing the mainboard, and hardware devices on it, check the items in your package with the list below.

If any of the items listed below is damaged or missing, please contact with your vendor.

1.2 Packing Contents

- **Mainboard**

- 1 x BC77Q

- **Cable**

- 2 x Serial ATA Cable
- 2 x COM port Cable

- **Accessories**

- 1 x BC77Q I/O Shield

- **Software CD**

- 1 x CD contains drivers, user's manual, and QIG (Quick Installation Guide)

- **Documentation**

- 1 x QIG (Quick Installation Guide)

1.3 Special Features

1.3.1 Product Highlights

- **Intel® i7/i5/i3 LGA1155 Processor Support**

This mainboard supports the 3rd / 2nd generation Intel® i7/i5/i3 processors in the LGA1155 package.

- **Intel® Q77 Express Chipset**

The Intel® Q77 PCH provides all business with more effective costs management, safer computing environment, and deploys more responsive PCs.

- **DDR3 Memory Support**

The mainboard supports DDR3 memory that features data transfer rates of 1066/ 1333/ 1600MHz (**note: 1600MHz only works with 3rd generation Intel core i7/i5/i3 processors**) to meet the higher bandwidth requirements of the latest 3D graphics, multimedia, and Internet applications.

- **High Definition Audio**

The mainboard came with the Realtek ALC892 high-definition audio CODEC that lets you enjoy high quality 7.1+2 channel audio without having to buy advanced sound cards.

- **PCI-E x16 support**

The PCI-E x16 VGA interface specification enhances graphics performance with high bandwidth (PCIEX16 slot only).

- **USB 3.0 Technology**

The mainboard implements the Universal Serial Bus (USB) 3.0 specification, which provides transfer rate up to 4.8Gbps. USB3.0 is backward compatible with USB2.0.

- **Trusted Platform Module (TPM) Support**

By combining the onboard TPM 1.2 with TPM security software (provided by the third party), it will enhance the security level of the system.



• **PRECAUTION: When TPM is enabled and utilized through TPM software, there is possibility that the encrypted data will not be accessible, or recoverable if one of the following situations occurred:**

1. Lost of TPM password.
2. System or board failure, or being replaced.
3. Hard Drive failure.

1.4 Before you proceed

Take note of the following precautions before you install mainboard components or change any mainboard settings.

- **Unplug the power cord from the wall socket before touching any component inside the system.**
- **Use a grounded wrist strap or touch a safely grounded object or to a metal object, such as the power supply case, before handling components to avoid damaging them due to static electricity.**
- **Hold components by the edges to avoid touching the ICs on them.**
- **Whenever you uninstall any component, place it on a grounded antistatic pad or in the bag that came with the component.**
- **Before you install or remove any component, ensure that the ATX power supply is switched off or the power cord is detached from the power supply. Failure to do so may cause severe damage to the mainboard, peripherals, and/or components.**

1.5 Mainboard Overview

Before you install the mainboard, study the configuration of your chassis to ensure that the mainboard fits into it.



Make sure to unplug the power cord before installing or removing the mainboard. Failure to do so can cause you physical injury and damage mainboard components.

1.5.1 Placement Direction

When installing the mainboard, make sure that you place it into the chassis in the correct orientation. The edge with external port goes to the rear part of the chassis as indicated in the image below.

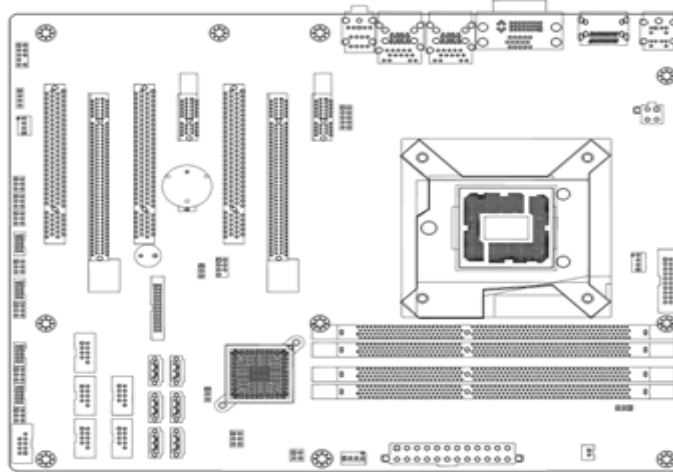

1.5.2 Mounting Holes

Place the screws into the mounting holes indicated by red squares to secure the mainboard to the chassis.



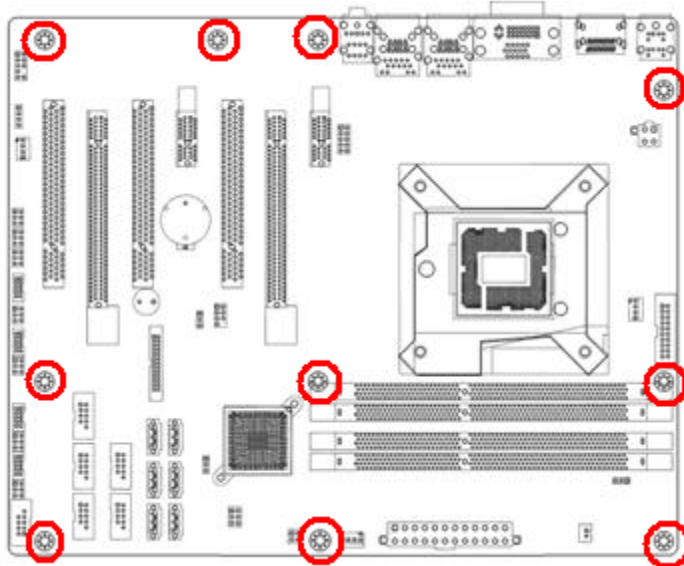

Do not over-tighten the screws! Doing so may damage the mainboard.

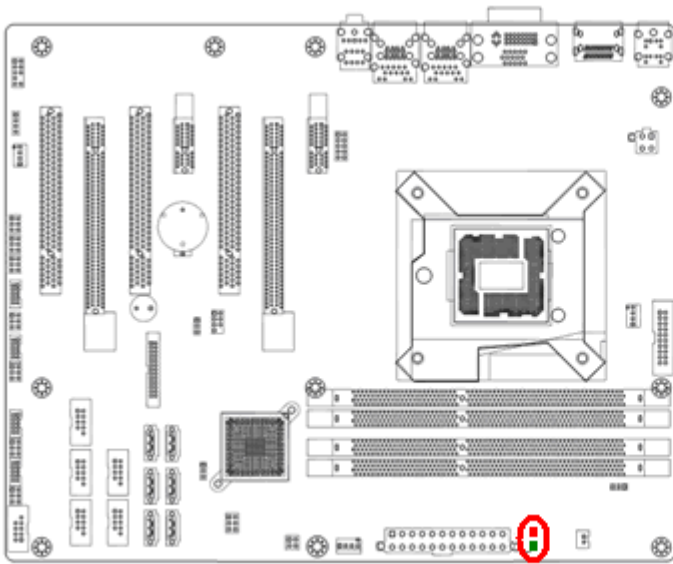

1.5.3 Onboard LEDs

The mainboard comes with a “Power On LED” (green) and one “Standby Power LED” (red) to indicate the system status. When the “Standby Power LED” lights on: It means the system is either in the standby state, or the power cable is still connected to the power source. The “Power On LED” lights on/off to indicate that the system status, in sleep mode, or in soft-off mode. This is a reminder that you should shut down the system and unplug the power cable before removing or plugging in any mainboard component. The illustration below shows the locations of onboard LEDs.



-  D35: Standby Power LED (Red)
-  D34: Power On LED (Green)

1.5.4 Mainboard Layout

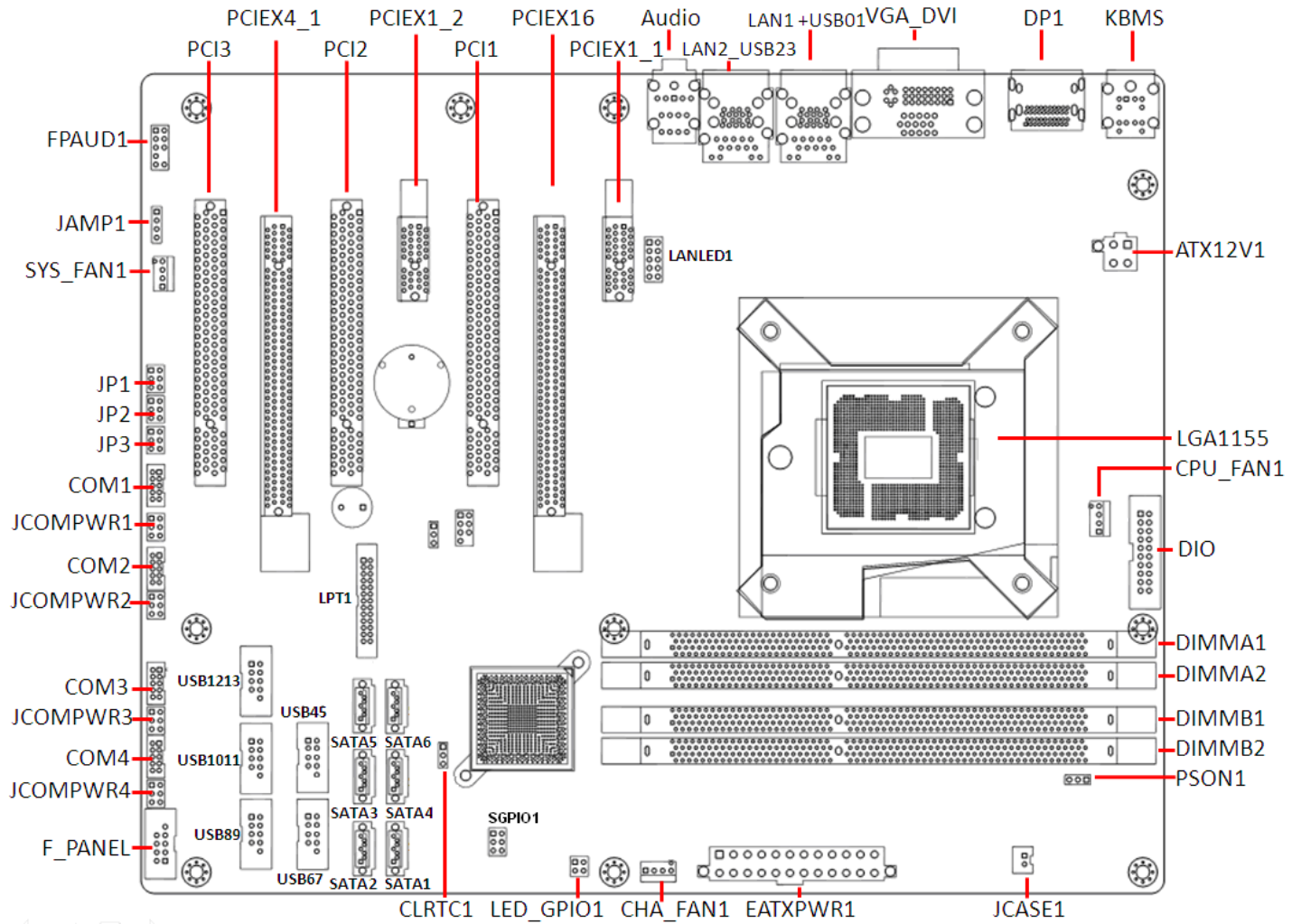

1.5.5 Layout Content List

• 1.5.5.1 Slots

Label	Function	Note	Page
DIMMA1	240-pin DIMM slot 1	1. If there is only one memory module being installed in the system, install it on this slot first. 2. If there are only two memory modules being installed in the system, install these 2 modules on “DIMMA1” and “DIMMB1” first.	31
DIMMA2	240-pin DIMM slot 2		31
DIMMB1	240-pin DIMM slot 3	If there are only two memory modules being installed in the system, install these 2 modules on “DIMMA1” and “DIMMB1” first.	31
DIMMB2	240-pin DIMM slot 4		31
PCIEX16	PCI express x16 slot		51
PCIEX4_1	PCI express x4 slot		51
PCIEX1_1 PCIEX1_2	PCI express x1 slot		51
PCI1 PCI2 PCI3	PCI slot		51

• 1.5.5.2 Internal Jumpers

Label	Function	Note	Page
CLRTC1	Clear CMOS	3 x 1 header, pitch 2.54mm	48
JP1, JP2, JP3	COM1 RS232/RS422/RS485 Select	3 x 2 header, pitch 2.00mm	48
JCOMPWR1 JCOMPWR2 JCOMPWR3 JCOMPWR4	COM1, COM2, COM3, COM4 RI/+5V/+12V Select	3 x 2 header, pitch 2.00mm	49
PSON1	AT/ATX Power Select	3 x 1 header, pitch 2.54mm	49

• 1.5.5.3 Internal Headers

Label	Function	Note	Page
ATX12V1	ATX Power Connector	2 x 2 header	37
EATXPWR1	ATX Power Connector	12 x 2 header	37
SATA1 SATA2 SATA3 SATA4 SATA5 SATA6	Serial ATA Connectors 1~6	7-pin header	40
CPU_FAN1	CPU Fan Connector	4 x 1 wafer, pitch 2.54mm	41
CHA_FAN1	Chassis Fan Connector	4 x 1 wafer, pitch 2.54mm	41
SYS_FAN1	System Fan Connector	4 x 1 wafer, pitch 2.54mm	41
JCASE1	Chassis Intrusion Connector	2 x 1 header, pitch 2.54mm	42
FPAUD1	Front Panel Audio Connector	5 x 2 header, pitch 2.54mm	43
JAMP1	Amplifier Connector	4 x 1 header, pitch 2.54mm	44
USB45 USB67 USB89 USB1011 USB1213	USB 2.0 Connector	5 x 2 header, pitch 2.54mm	44
COM1 COM2 COM3 COM4	Serial Port Connector 1, 2, 3, 4	5 x 2 header, pitch 2.00mm	45
LPT1	Parallel Port Connector	13 x 2 header, pitch 2.00mm	45
F_PANEL	System Panel Connector	5 x 2 header, pitch 2.54mm	46
LANLED1	LAN LED header	5 x 2 header, pitch 2.54mm	46
DIO	Digital I/O header	10 x 2 header, pitch 2.54mm	47
SGPIO1	RAID LED header	6 x 2 header, pitch 2.00mm	47
LED_GPIO1	PC OK Connector (Factory use only)	2 x 2 header, pitch 2.00mm	-
SPI_CN	SPI pin header (Factory use only)	4 x 2 header, pitch 2.54mm	46

• 1.5.5.4 Back Panel Connectors

Label	Function	Note	Page
KBMS	PS/2 keyboard and mouse	6-pin Mini-Din	37, 38
VGA/ DVI	VGA Connector x 1 DVI Connector x 1	D-sub 15-pins, female Dual Link DVI-D; 24-pins	37, 38
DP1/ DP2	Display Port x 2 (COM1/ COM2)		37, 38
LAN1/ LAN2	RJ-45 Ethernet Connector x 2		37
USB	USB3.0 Connector x 4		38
AUDIO	Line-in Port, Line-out Port, Microphone Port,	5.1 Channel Audio I/O (3 jacks)	37

1.6 Central Processing Unit (CPU)

This mainboard supports the Intel® LGA1155 socket for 3rd / 2nd generation Intel® Core™ i7/i5/i3 32nm desktop processors. If you do not have the CPU cooler, consult with your dealer before turning on the system.

- Your boxed Intel® LGA1155 processor package should come with installation instructions for the CPU, fan, heatsink, and the retention assembly.
- Upon purchase of the mainboard, make sure that the PnP cap is on the socket and the socket pins are not bent. Contact your retailer immediately if the PnP cap is missing, or if you see any damage to the PnP cap/socket pins/mainboard components. BCM will shoulder the cost of repair only, if the damage is shipment/ transit-related.
- Keep the PnP cap after installing the mainboard. BCM will process Return Merchandise Authorization (RMA) requests only if the mainboard comes with the cap installed on the LGA1155 socket.
- The product warranty does not cover damage to the socket pins resulting from incorrect CPU installation/ removal, or misplacement/ loss/ incorrect removal of the PnP cap.



1. **Overheating: Overheating will seriously damage the CPU and mainboard. Always make sure the cooling fan can work properly to protect the CPU from overheating.**
2. **Make sure that you apply an even layer of thermal paste between the CPU and the heatsink to enhance heat dissipation.**
3. **Replacing the CPU: While replacing the CPU, always turn off the ATX power supply or unplug the power supply's power cord from the grounded outlet first in order to prevent damage to the system.**

1.6.1 Installing the CPU

To install a CPU

1. Locate the CPU socket (LGA1155 Socket) on the mainboard.

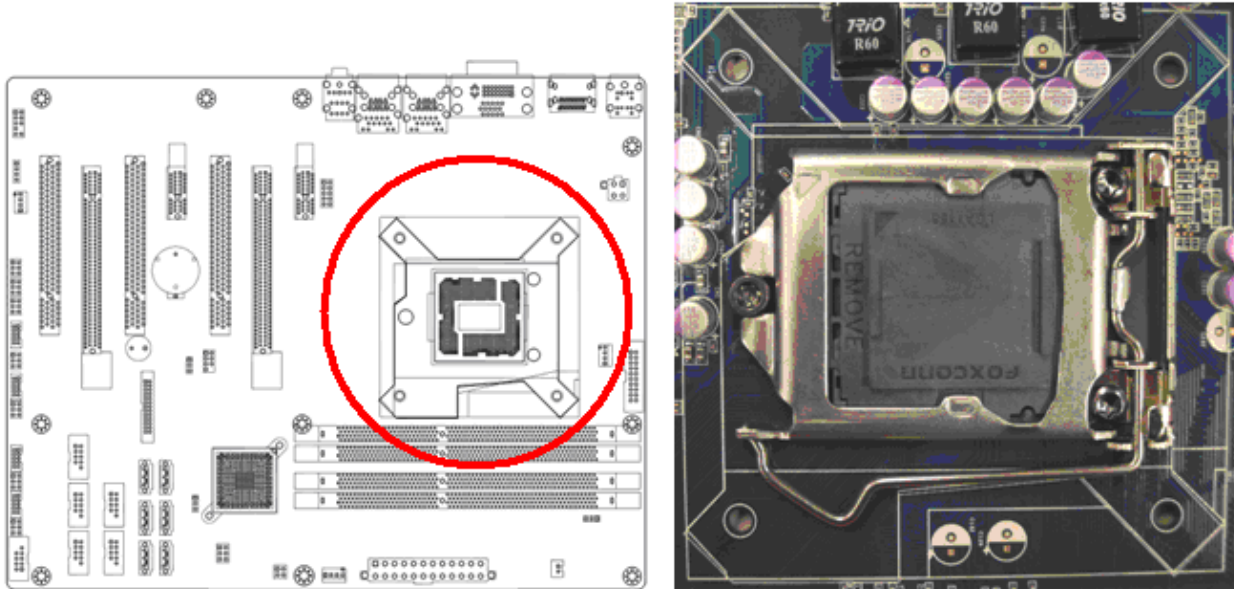

2. Unlatch the “CPU Socket Lever” by pressing the lever down and move it away from the main structure of the socket.

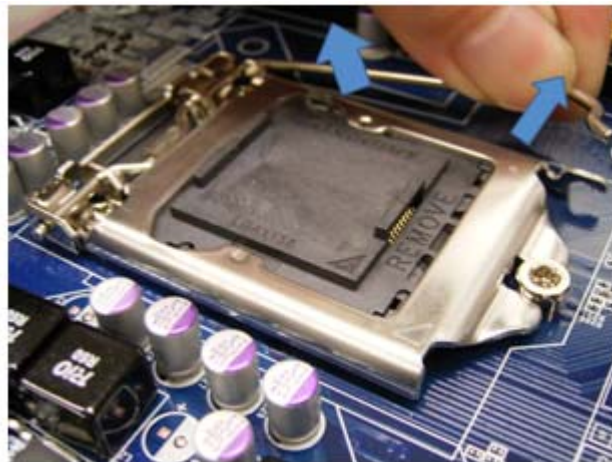

To prevent damage to the socket pins, do not remove the “CPU Socket Cover” (PnP cap) unless you are going to install a CPU.

3. Lift the load lever up in the direction of the arrow to a 135° angle, so the metal “CPU Socket Cover” can also be lifted.

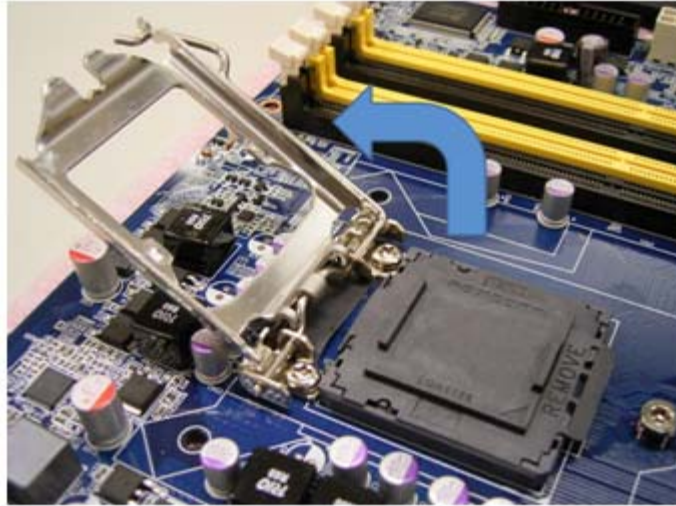

4. The CPU socket has a plastic protection cap installed on it (black color, a.k.a. “CPU Socket Cover”, or “PnP cap”) in order to protect the socket pins from damage. If you are going to install a CPU, remove the plastic protection cap away from the CPU socket by lifting it up

(NOTE: Please do not discard this plastic protection cap. Just in case if you need to RMA this board in the future, you need to install this plastic protection cap in order to protect the CPU socket)

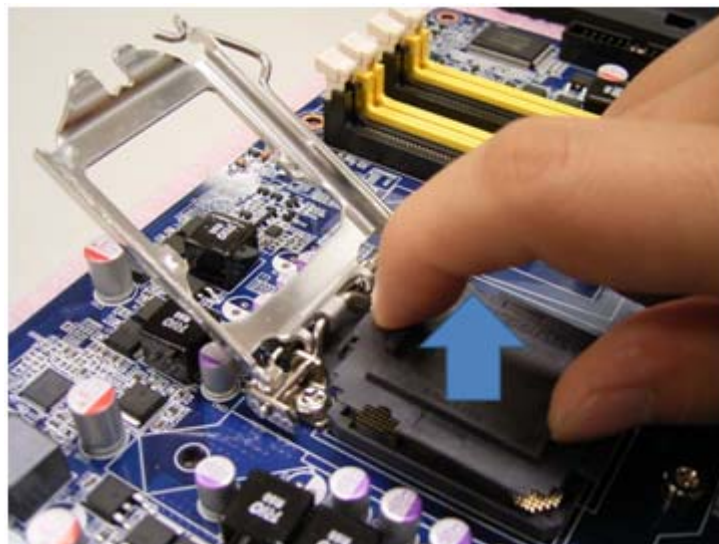

5. There are two notches on the CPU itself (one on each side), and there are two “Socket Alignment keys” on the CPU socket as well. Line up the two CPU notches with the “Socket Alignment Keys” on the socket, and insert the CPU into the CPU socket slowly.

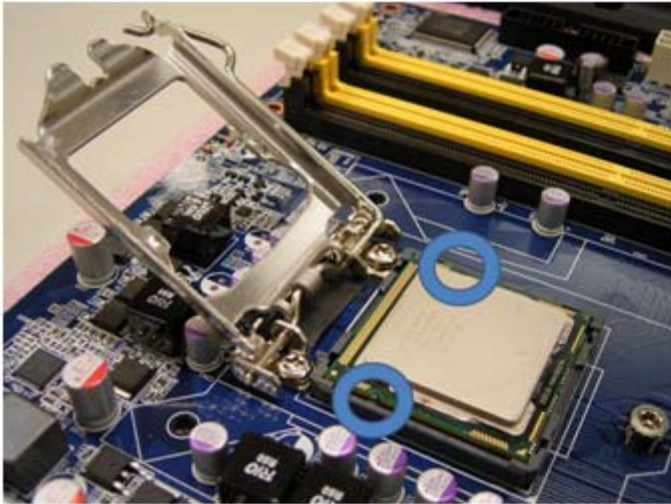

6. Visually inspect if the CPU is seated into the CPU socket evenly. The “Socket Alignment keys” should fit into the CPU notches.

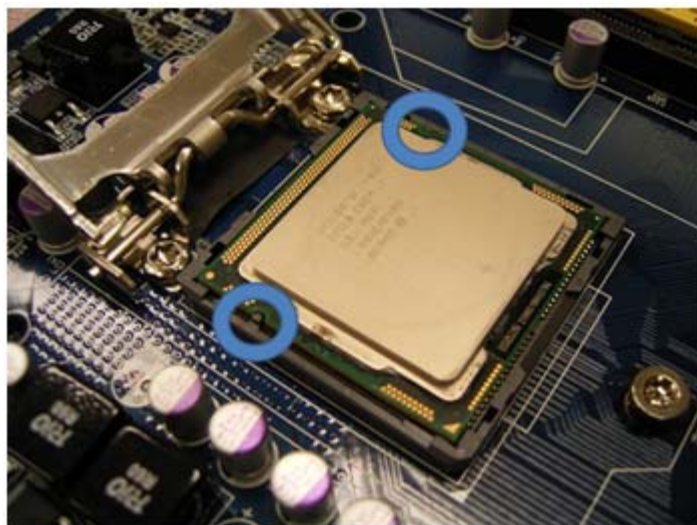

7. Close the “CPU Socket Cover” by lowering down the “CPU Socket Lever”. Make sure the “CPU Socket Front Plates” are sliding underneath the “Shoulder Screw Cap”.

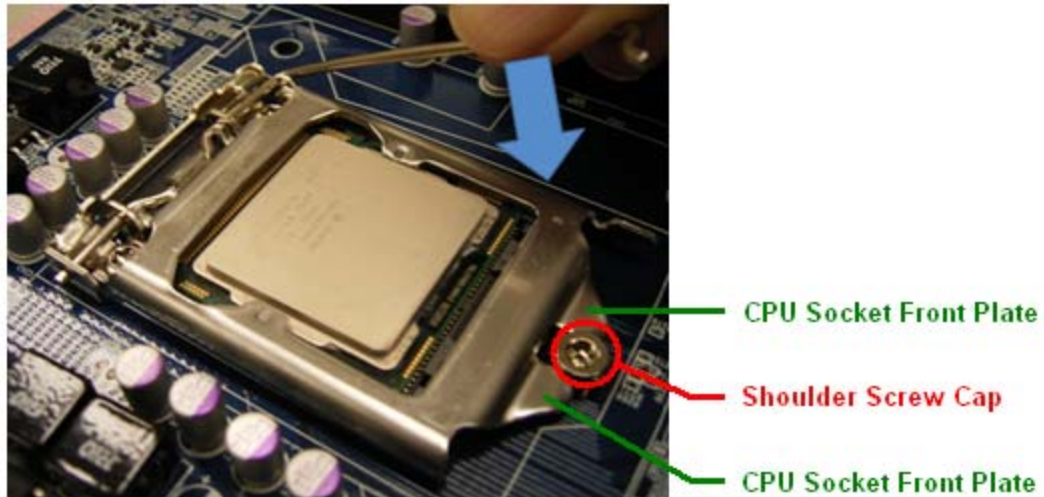

8. Secure the “CPU Socket Cover” by keep pressing down the “CPU Socket Lever” and move it toward and underneath the “Load Plate Tab”.

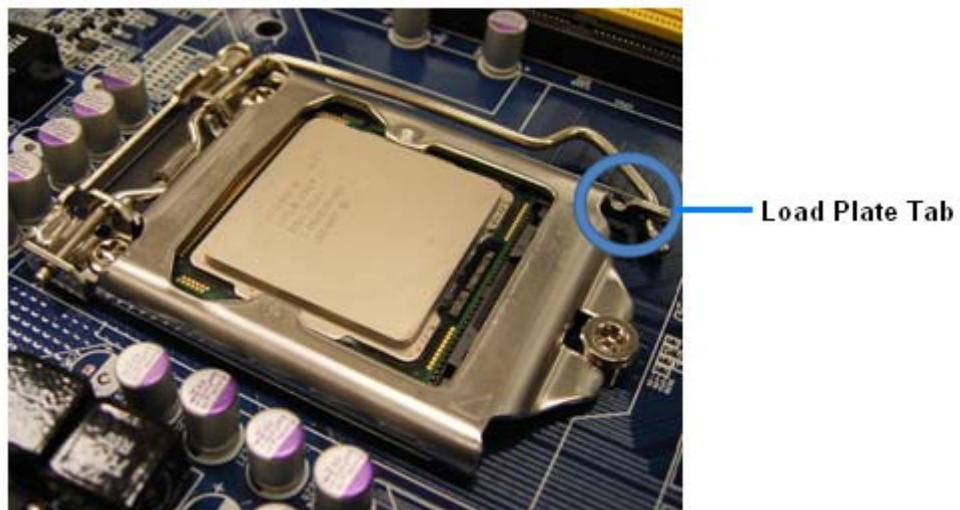

The CPU fits in only one correct orientation, DO NOT force the CPU into the socket. Otherwise, it might damage the CPU and/or the CPU socket.

1.6.2 Installing the CPU Heatsink and Fan

The Intel LGA1155 processor requires a specially designed heatsink and fan assembly to ensure optimum thermal condition and performance.

- When you purchase a boxed Intel® processor, the package includes the CPU fan and heatsink assembly. If you buy a CPU separately, make sure that you only use Intel®-certified multi-directional heatsink and fan.
- Your Intel® LGA1155 heatsink and fan assembly comes in a push-pin design and requires no tool to install.
- If you purchased a separate CPU heatsink and fan assembly, make sure that:
 - a. The CPU heatsink and fan assembly is designed to withstand the “TDP” (Thermal Dissipation Power) specified by Intel specification of corresponding CPU that you are going to install.
 - b. You have properly applied an even layer of “Thermal Interface Material” to between the CPU heatsink and the top of CPU before you install the heatsink and fan assembly (please check with your CPU fan/heatsink vendor for details).

NOTE: Make sure that you have installed the mainboard to the chassis before you install the CPU fan and heatsink assembly.

To install the CPU heatsink and fan:

1. Place the CPU heatsink on top of the installed CPU, make sure that the four fasteners are line-up with the four “motherboard hole” around the CPU socket.

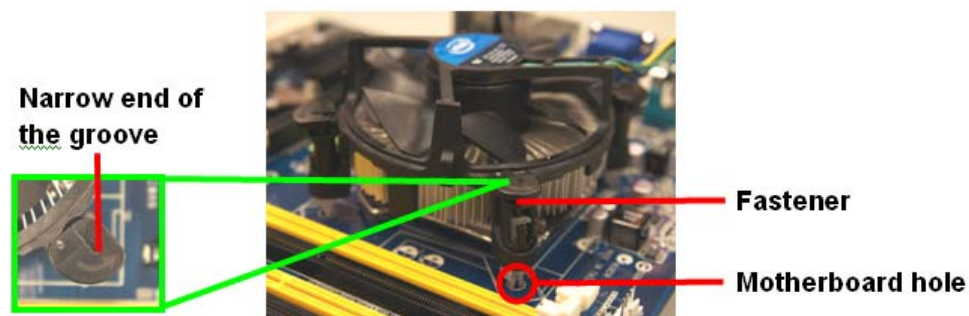

NOTE: Orient the heatsink and fan assembly so the CPU fan cable is close to the CPU fan connector).



Make sure to orient each fastener with the narrow end of the groove pointing outward. (The photo shows the groove shaded for emphasis.)

2. Push down two fasteners at a time in a diagonal sequence to secure the heatsink and fan assembly in place.

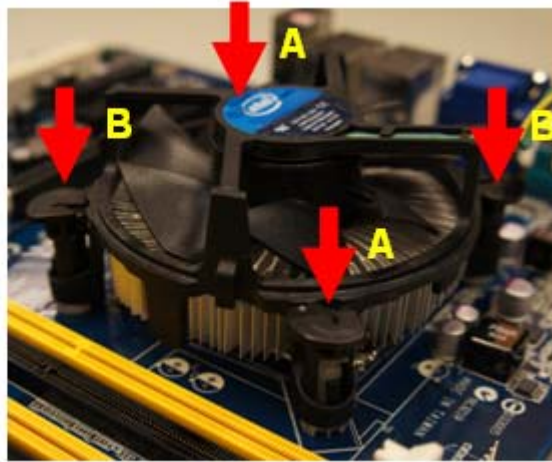
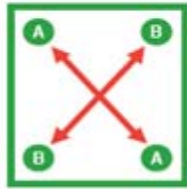

3. Connect the CPU fan cable to the connector on the motherboard labeled "CPU_FAN1".

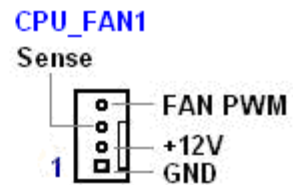
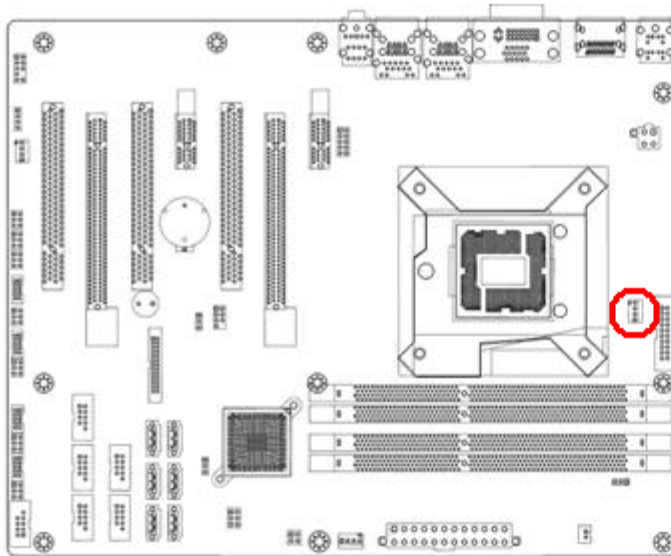

1. Do not forget to connect the CPU fan connector. Insufficient air flow inside the system chassis may damage the mainboard components. Hardware monitoring errors can occur if you fail to plug in this connector.
2. Do not install any pin connector on the header "CPU_FAN1", doing so may damage the mainboard.

1.6.3 Uninstalling the CPU Heatsink and Fan.

To uninstall the CPU heatsink and fan:

1. Disconnect the CPU fan cable from the connector on the mainboard.
2. Rotate each fastener counterclockwise.

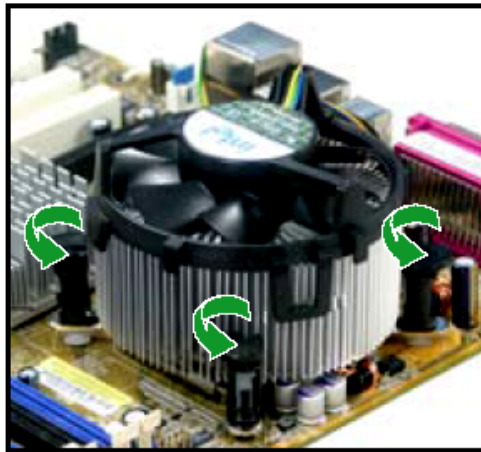

4. Pull up two fasteners at a time in a diagonal sequence to disengage the heatsink and fan assembly from the mainboard.

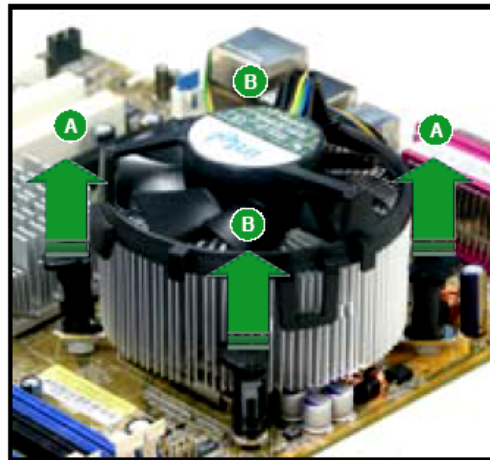
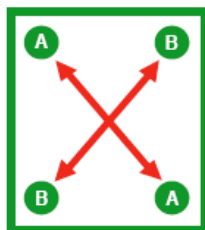

5. Rotate each fastener clockwise to ensure correct orientation when reinstalling.

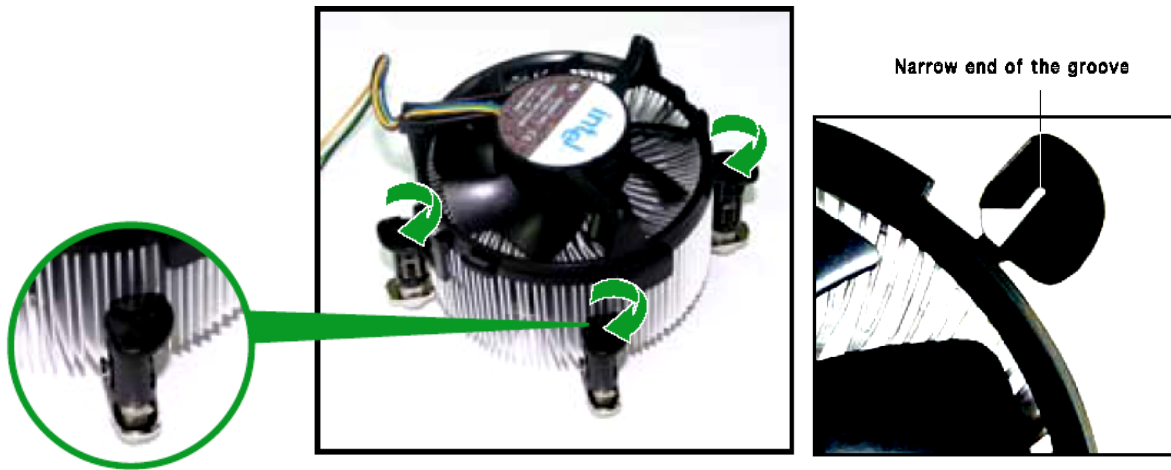

**The narrow end of the groove should point outward after resetting.
(The photo shows the groove shaded for emphasis.)**

1.7 System Memory

1.7.1 Overview

The mainboard comes with four 240-pin Double Data Rate 3 (DDR3) Dual Inline Memory Modules (DIMM) slots. You may **ONLY** use **1600MHz (PC3-12800, only works with 3rd generation Core i7/ i5/ i3 processors)**, or **1066MHz (PC3-8500)**, or **1333MHz (PC3-10600)**; **Non-ECC, Un-buffered 1.5V DDR3 memory modules on this board (8GB maximum for each slot).**

DDR3 DIMMs are notched differently to prevent installation on a DDR2 DIMM socket. The following figure illustrates the location of memory slots.

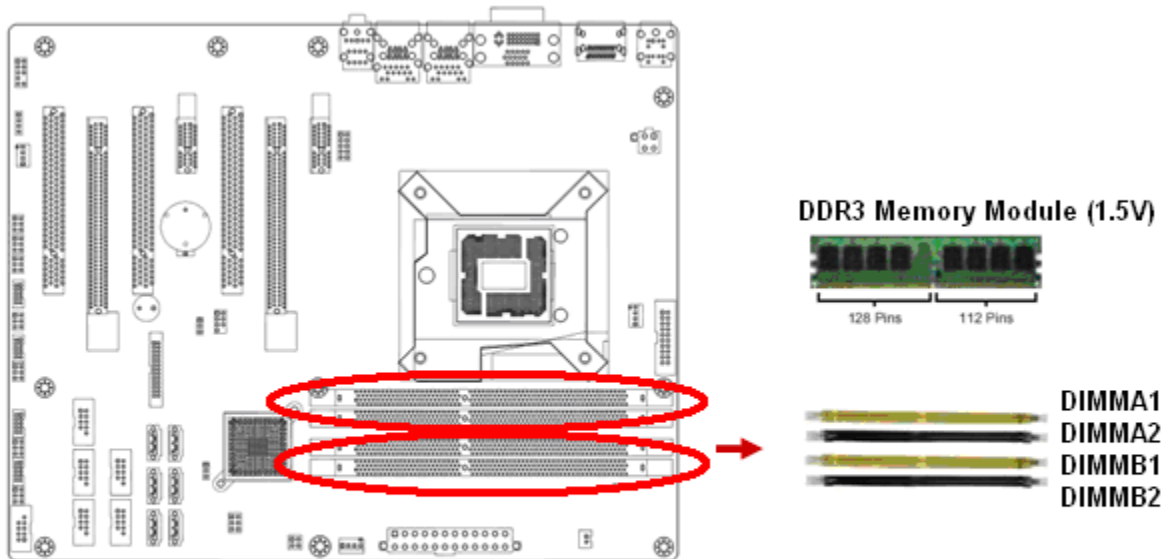

Channel	Socket
Channel A	DIMMA1 & DIMMA2
Channel B	DIMMB1 & DIMMB2

1.7.2 Configurations of Supported Memory Modules (Non-ECC, Unbuffered)

Memory Module Capacity	Configuration (Chips populated on single side or both sides of memory module)	SDRAM Density	SDRAM Organization Front-side/ Back-side	Number of SDRAM Devices (total of memory chips on each memory module)
1GB	Single sided	1 Gbit	128M x8 /empty	8
2GB	Double sided	1 Gbit	128M x8/ 128M x 8	16
2GB	Single sided	2 Gbit	256M x8/ empty	8
4GB	Double sided	2 Gbit	256M x8/ 256M x8	16
4GB	Single sided	4 Gbit	512M x8/ empty	8
8GB	Double sided	4 Gbit	512M x8/ 512M x8	16

1.7.3 Dual-Channel Mode Population Rule

In Dual-Channel mode, the memory modules can transmit and receive data with two data bus lines simultaneously. Enabling Dual-Channel mode can enhance the system performance. Please refer to the following illustrations for population rules under Dual-Channel mode.

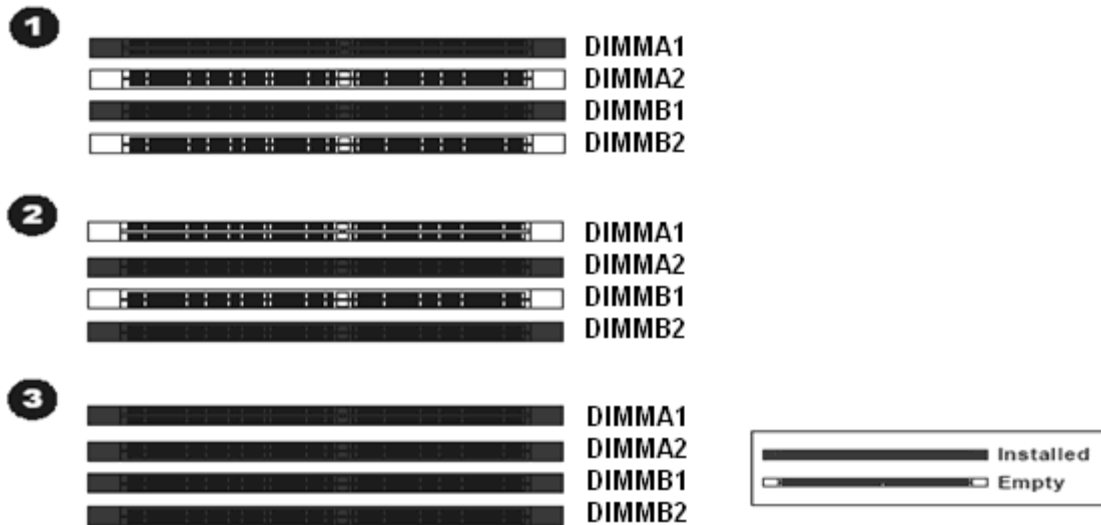

- Install at least 1GB of memory module onboard.
- When install only one DDR3 memory module, install it on “DIMMA1” slot ONLY.
- When install only two DDR3 memory module, install them on “DIMMA1” and “DIMMB1” slots ONLY.
- In dual-channel configurations, install only identical (the same type, and size) DDR3 memory module paired for each channel. For instance, DIMMA1 paired with DIMMB1; DIMMA2 paired with DIMMB2.
- Always install DIMMs with the same CAS latency. For optimum compatibility, it is recommended that you obtain the exact same model of memory modules from the same vendor.

1.7.4 Installing DIMM



Make sure to unplug the power supply before adding or removing DIMMS or other peripherals from the system. Failure to do so may cause severe damage to both the mainboard and the peripherals.

1. Unlock a DIMM socket by pressing the retaining clips outward.
2. Align a DIMM on the socket such that the notch on the DIMM matches the break on the socket.

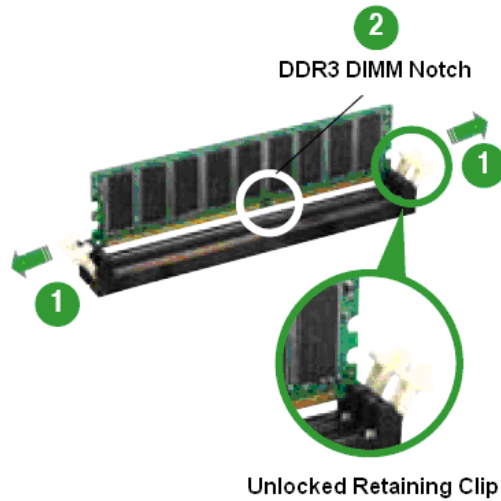

3. Firmly insert the DIMM into the socket until the retaining clips snap back in place and the DIMM is properly seated.

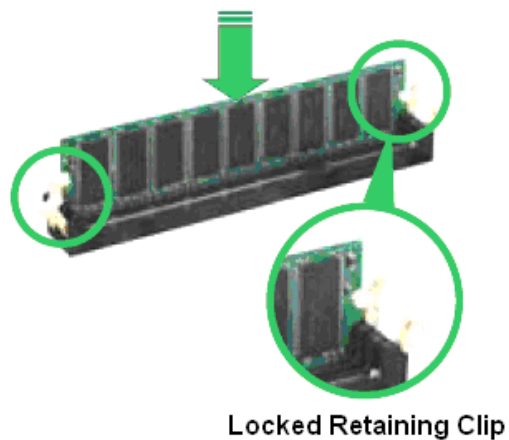



1. **A DDR3 memory module is keyed with a notch so that it fits in only one direction.**
2. **DO NOT force the memory module into the socket in order to avoid damaging the memory module and the slot.**
3. **DDR3 memory modules are not interchangeable with DDR or DDR2.**
4. **DDR3 standard IS NOT backward compatible. You shall only install the DDR3 memory modules on this mainboard.**
5. **To enable the system boot-up successfully, always install the memory module into the DMMA1 slot first.**

1.7.5 Removing DIMM

Follow these steps to remove a DIMM.

1. Simultaneously press the retaining clips outward to unlock the DIMM.

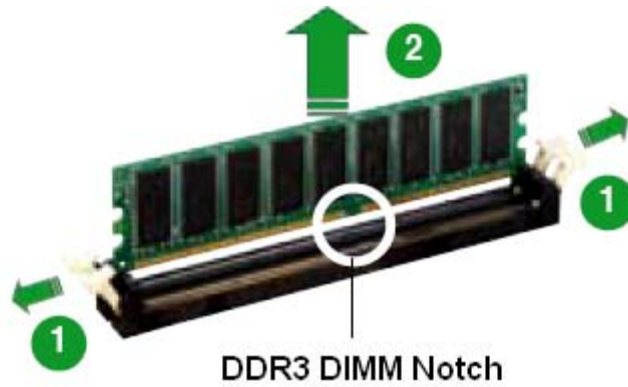

2. Remove the DIMM from the socket.

1.8 Power Supply

1.8.1 ATX Power Connectors: EATXPWR1, ATX12V1

These ATX power connectors provide connections from power supply unit (PSU) to the mainboard. Both connectors need to be installed in order for the mainboard to function properly. The power supply plugs are designed to fit with these ATX power connectors in one orientation only. To connect these power supply plugs; find the proper orientation first, and then push down the power supply plugs firmly until the connectors are completely fit.

If you'd like to use the 20-pin ATX power supply, please align the 20-pin power connector from PSU to pin 1 & pin 13 of "EATXPWR1". There is also a foolproof design on pin 11, 12, 23, & 24 to avoid wrong installation.

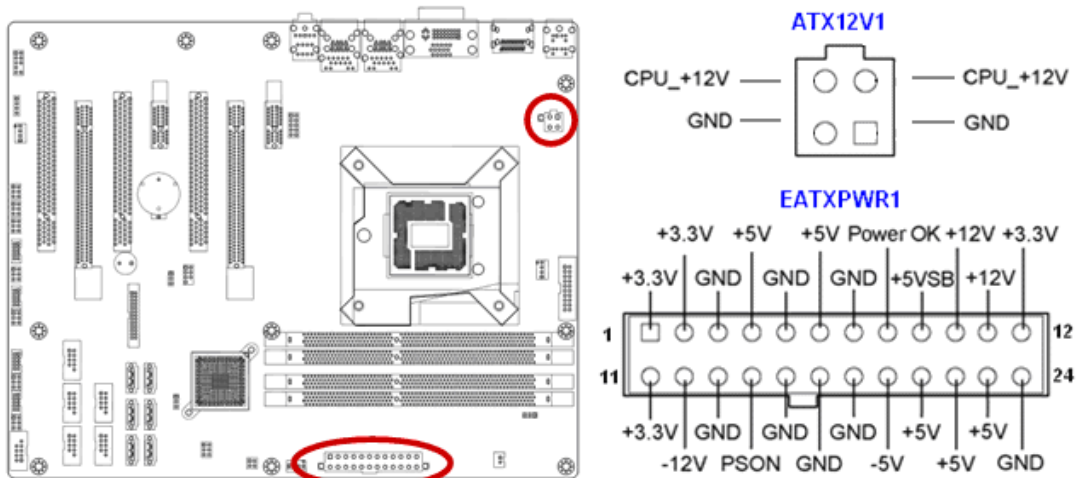

1. It is recommended that you use a power supply unit (PSU) that complies with ATX 12V specification 2.0 (or later version) and provides a minimum power of 500W. If you are planning to fully load the slots and/or use a PCI-E x16 graphic card, a power supply with minimum power of 600W or more might be needed.
2. Do not forget to connect the 4-pin "ATX12V1" power plug; otherwise, the system will not boot.
3. Use of a PSU with a higher power output is recommended when configuring a system with more power-consuming devices. The system may become unstable or may not boot if the power supply is inadequate.

1.9 Back Panel

1.9.1 Back Panel Connectors

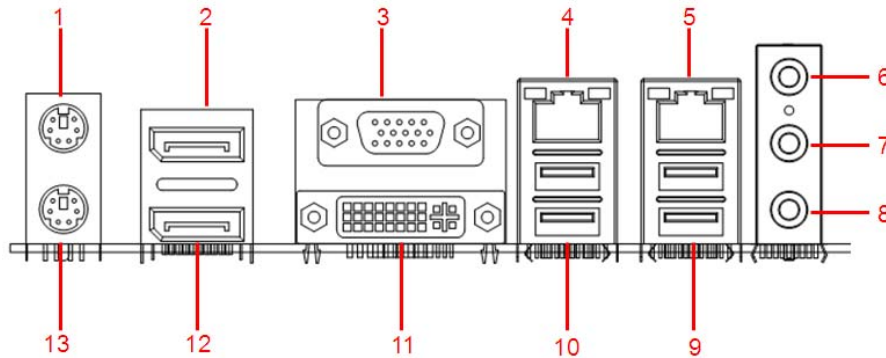

Item	Name	Function	Description																				
1	KBMS	PS/2 Mouse Connector	The port is for a PS/2 mouse.																				
2	DP1	Display Port 2	Provides "displayport" type connection to monitor.																				
3	VGA	VGA Video Port	The VGA15-pin Connector.																				
4/5	LAN1/ LAN2	Gigabit LAN (RJ-45) Connectors	<p>This port allows Gigabit connection to a Local Area Network (LAN) through a network hub. Refer to the table below for the LAN port LED indications.</p> <table border="1"> <thead> <tr> <th colspan="2">ACT/Link LED</th> <th colspan="2">Speed LED</th> </tr> <tr> <th>Status</th> <th>Description</th> <th>Status</th> <th>Description</th> </tr> </thead> <tbody> <tr> <td>OFF</td> <td>No link</td> <td>OFF</td> <td>10Mbps connection</td> </tr> <tr> <td>Orange</td> <td>Linked</td> <td>Orange</td> <td>100Mbps connection</td> </tr> <tr> <td>Blinking</td> <td>Data activity</td> <td>Green</td> <td>1Gbps connection</td> </tr> </tbody> </table>	ACT/Link LED		Speed LED		Status	Description	Status	Description	OFF	No link	OFF	10Mbps connection	Orange	Linked	Orange	100Mbps connection	Blinking	Data activity	Green	1Gbps connection
ACT/Link LED		Speed LED																					
Status	Description	Status	Description																				
OFF	No link	OFF	10Mbps connection																				
Orange	Linked	Orange	100Mbps connection																				
Blinking	Data activity	Green	1Gbps connection																				
6	AUDIO	Line-in port (Light blue)	This port connects a tape, CD, DVD player, or other audio sources.																				
7	AUDIO	Line-out port (Lime)	This port connects a headphone or a speaker. In 4-channel, 6-channel, and 8-channel configuration, the function of this port becomes Front Speaker Out.																				

8	AUDIO	Microphone port (Pink)	This port connects a microphone.
9	USB	USB 3.0 Connectors	These two 4-pin Universal Serial Bus (USB) ports are available for connecting USB 3.0/ 2.0 devices.
10	USB	USB 3.0 Connectors	These two 4-pin Universal Serial Bus (USB) ports are available for connecting USB 3.0/ 2.0 devices.
11	DVI	DVI Video Port	DVI-D 24-Pin Connector.
12	DP1	Display Port 1	Provides "displayport" type connection to monitor.
13	KBMS	PS/2 Keyboard Connector	This port is for a PS/2 keyboard.

1.10 Connectors/ Headers

1.10.1 Serial ATA Connectors: SATA3.0: SATA1, SATA2

SATA2.0: SATA3, SATA4, SATA5, SATA6

SATA ports “SATA1” and “SATA2” (in red color connectors) support SATA3.0 standard, which is backward compatible with SATA2.0.

SATA ports “SATA3” to “SATA6” (in blue color connectors) support SATA2.0 standard.

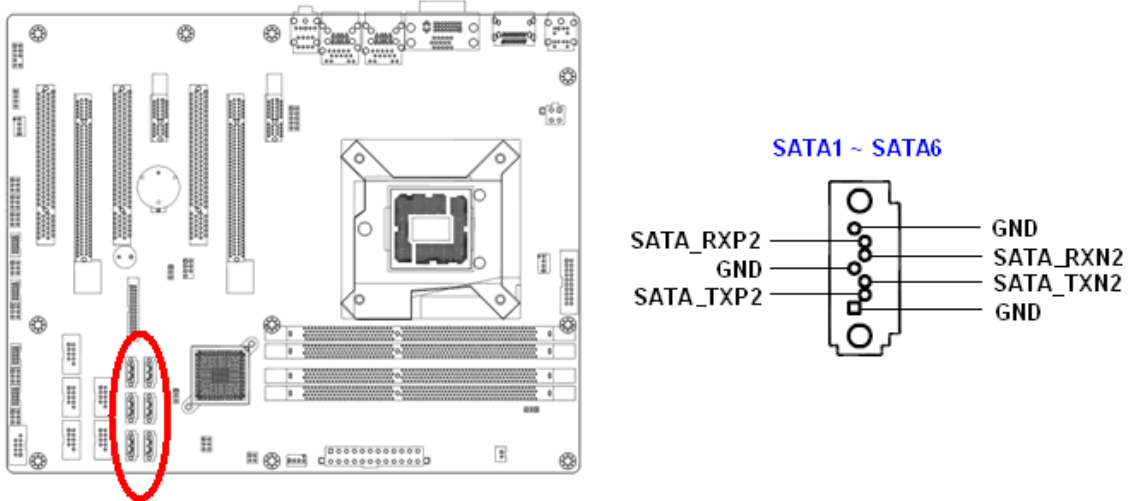

Please do not fold the Serial ATA cable into 90-degree angle. Otherwise, data loss may occur during data transmission.

1.10.2 Fan Power Connectors: CPU_FAN1, CHA_FAN1, SYS_FAN1

The fan power connectors support system cooling fan with +12V. When connecting the wire to these fan connectors, please note that the red wire is designated as “Power” and should be connected to “+12V” pin; the black wire is designated as “Ground” and should be connected to “GND”. In order to take the advantage of System Hardware Monitor, be sure to use the fan which is specifically designed with speed sensor.

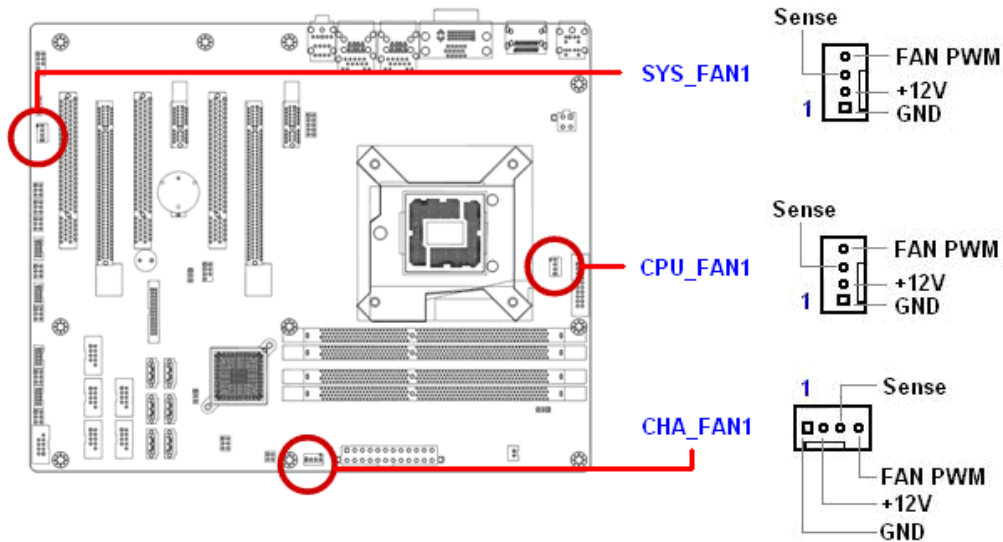

Please refer to the recommended CPU fans at processor’s official website or consult with the vendor for proper CPU cooling fan.

1.10.3 Chassis Intrusion Switch Connector: JCASE1

This connector connects to a 2-pin chassis switch. If the chassis is opened, the switch will be short. The system will record this status and show a warning message on the screen.

To clear the warning message, you must enter the BIOS and clear the record.

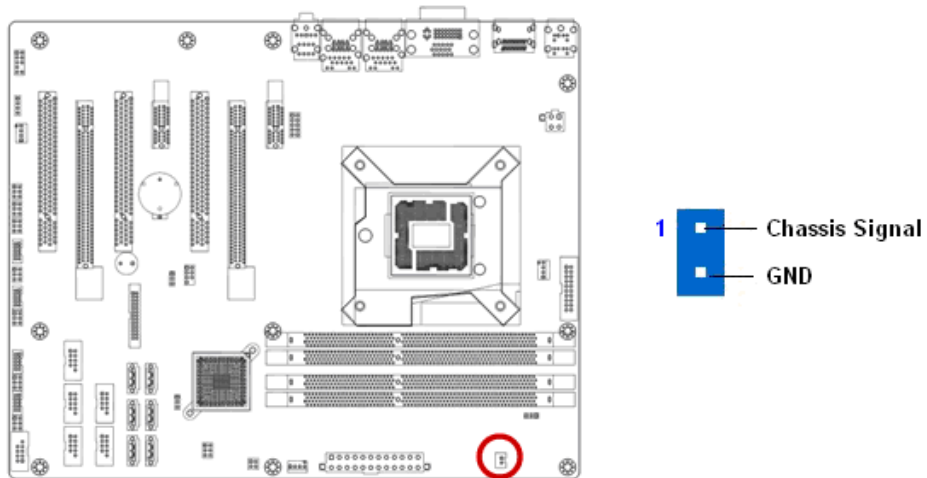

1.10.4 Front Panel Audio Connector: FPAUD1

This connector allows you to connect the front panel audio and is compliant with Intel® Front Panel I/O Connectivity Design Guide.

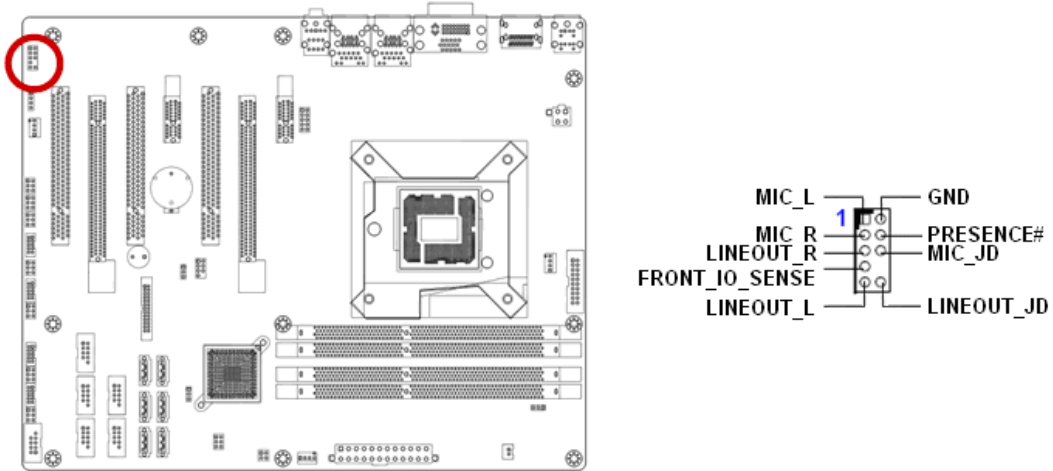

HD Audio Pin Definition

PIN	SIGNAL	DESCRIPTION
1	MIC_L	Microphone - Left channel
2	GND	Ground
3	MIC_R	Microphone - Right channel
4	PRESENCE#	Active low signal-signals BIOS that a High Definition Audio dongle is connected to the analog header. PRESENCE# = 0 when a High Definition Audio dongle is connected
5	LINE out_R	Analog Port - Right channel
6	MIC_JD	Jack detection return from front panel microphone JACK1
7	Front_JD	Jack detection sense line from the High Definition Audio CODEC jack detection resistor network
8	NC	No control
9	LINE out_L	Analog Port - Left channel
10	LINEout_JD	Jack detection return from front panel JACK2

1.10.5 Amplifier Connector: JAMP1

This header provided amplified audio signals to external speakers (2-channels). The dB level can be adjusted under BIOS.

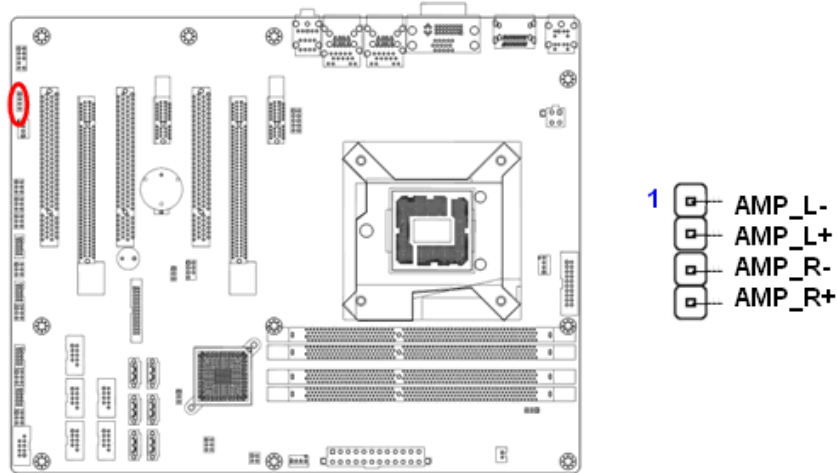

1.10.6 Front USB2.0 Headers: USB45, USB67, USB89, USB1011, USB1213

This connector is compliant with Intel® I/O Connectivity Design Guide, which is ideal for connecting high-speed USB peripherals such as USB HDD, USB digital cameras, USB MP3 players, USB printers, etc.

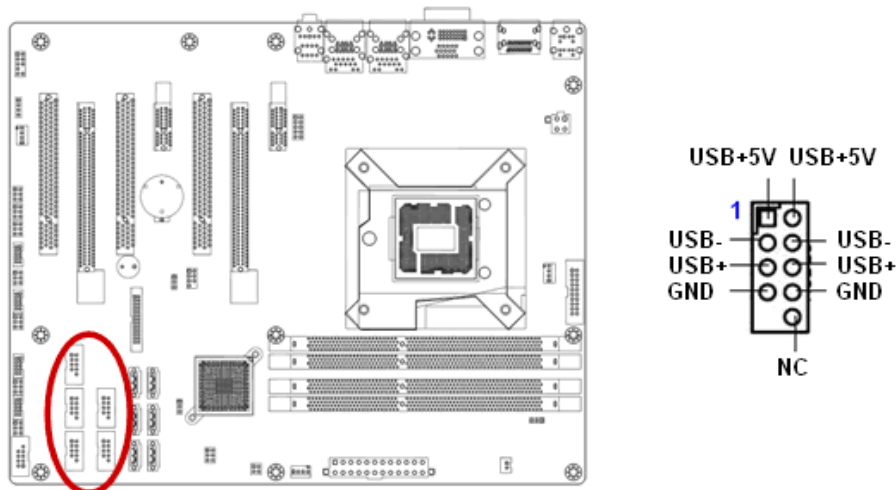

Be sure the pins of VCC and GND is connected to the connector correctly. Otherwise, it may cause damage to the USB port and/or the connected USB device.

1.10.7 Serial Port Connectors: COM1, COM2, COM3, COM4

This connector is a 16550A high speed communication port that sends/receives 16 byte FIFOs.

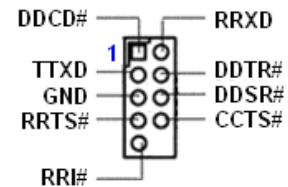
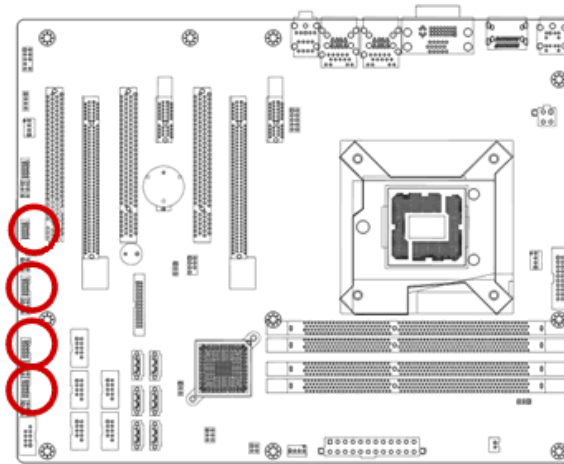

1.10.8 LPT Port Connector: LPT1

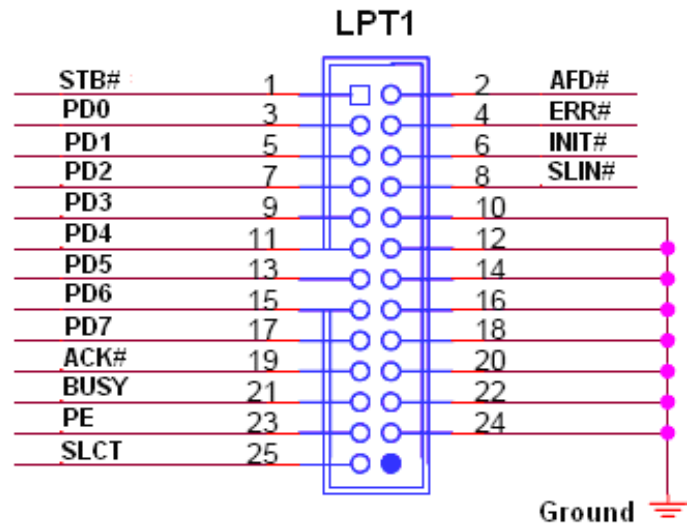
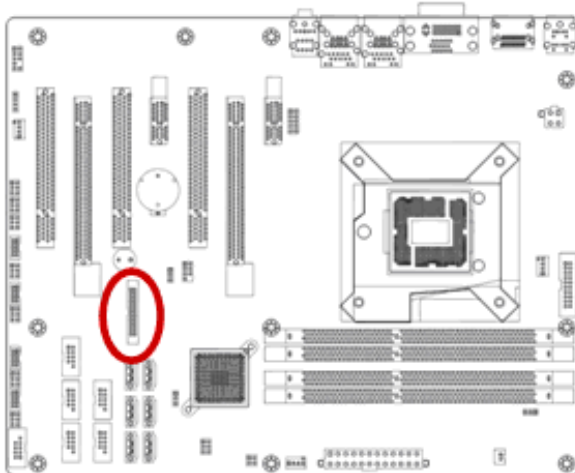

1.10.9 Front Panel Connectors: F_PANEL

These connectors are for electrical connections to the front panel switches and LEDs. The “F_PANEL1” connector is compliant with Intel® Front Panel I/O Connectivity Design Guide.

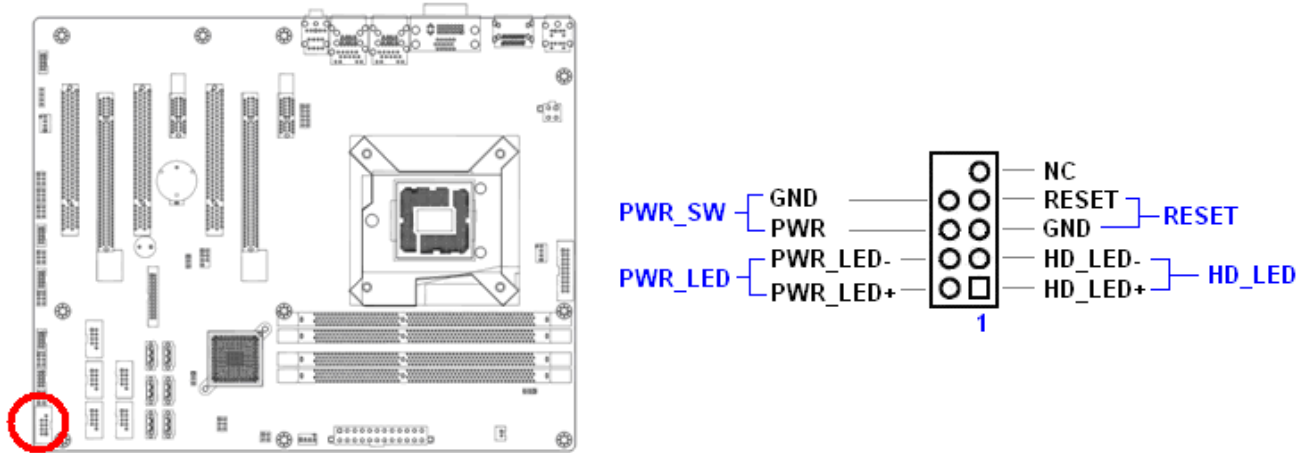

1.10.10 LANLED Header: LANLED1

The “LANLED1” header provides the option for front panel to display the LED status simultaneously with the corresponding RJ45 port. For the LAN speed LED connection, a “Dual-band Common Cathode LED” (3-pin LED) is recommended.

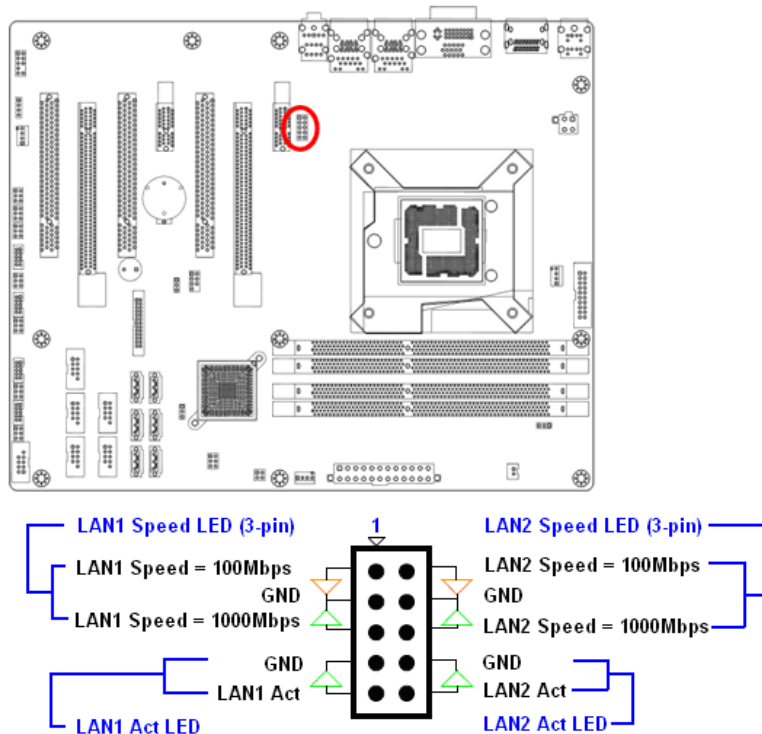

1.10.11 Digital I/O Connector: DIO

This header provides connections to GPIO ports.

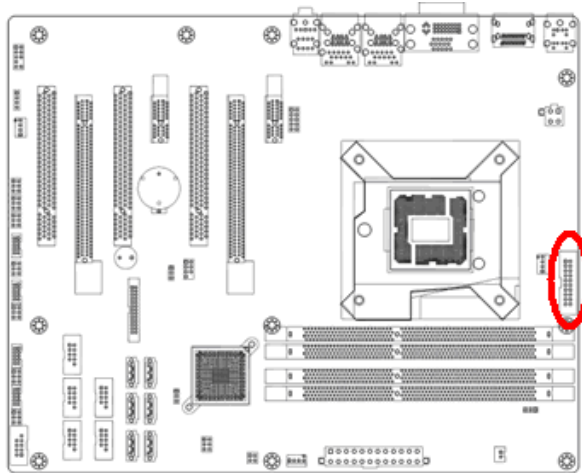

	1	2	
GPIO_8	□	○	GPIO_0
GPIO_9	○	○	GPIO_1
GPIO_10	○	○	GPIO_2
GPIO_11	○	○	GPIO_3
GPIO_12	○	○	GPIO_4
GPIO_13	○	○	GPIO_5
GPIO_14	○	○	GPIO_6
GPIO_15	○	○	GPIO_7
SMB SLK	○	○	SMB_DATA
GND	○	○	+5V

1.10.12 RAID LED Header: SGPIO1

This header is reserved.

1.10.13 The Header: SPI_CN

This header is reserved for factory use only.

1.11 Jumpers

1.11.1 Clear CMOS Jumper: CLRTC1

There is a CMOS RAM onboard that has a power supply from an external battery to keep the data of system configuration.

For normal state (default), the jumper is set on pin location 1 and 2.

To clear the CMOS, set the jumper to pin location 2 and 3 for at least 30 seconds while the system is off.

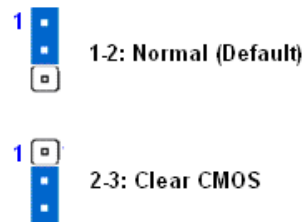
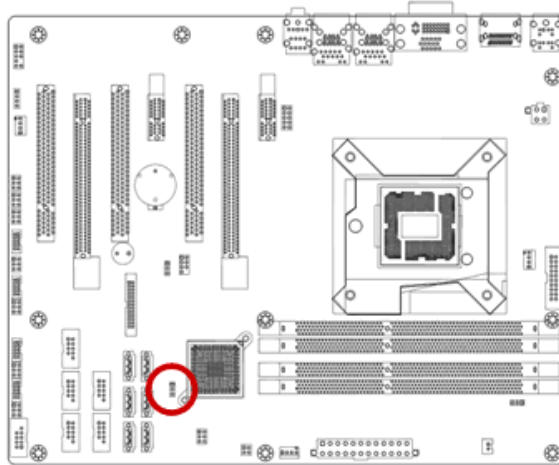

1. You can clear CMOS by shorting pin 2-3 for at least 30 seconds (while the system is OFF), then place the jumper back to pin 1-2 for normal operation.
2. Avoid clearing the CMOS while the system is ON; this will damage the mainboard.

1.11.2 COM1 RS232/ RS422/ RS485 Select: JP1, JP2, JP3

These jumpers provide combinations for RS232 (default), or RS422, or RS485 transfer mode on COM1 (rear I/O).

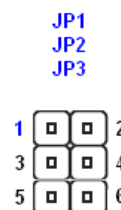
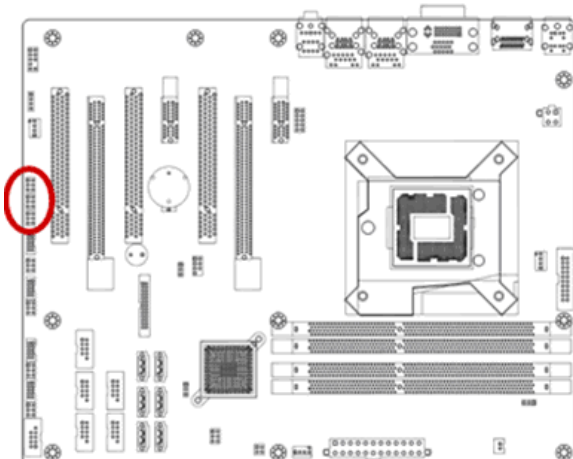

COM1 RS232/ RS422/ RS485 Settings			
Function	JP1	JP2	JP3
RS232 (Default)	1-3	1-2	1-3
	2-4		2-4
RS422	3-5	3-4	3-5
	4-6		4-6
RS485	3-5	5-6	3-5
	4-6		4-6

1.11.3 COM Port Ring-in/ +12V/ +5V Power Select: JCOMPWR1, JCOMPWR2, JCOMPWR3, JCOMPWR4

These headers provide ring-in, or 5V, or 12V on the com ports.

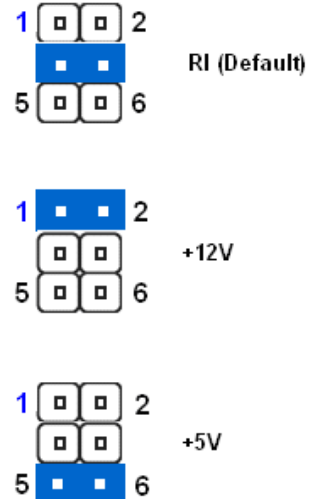
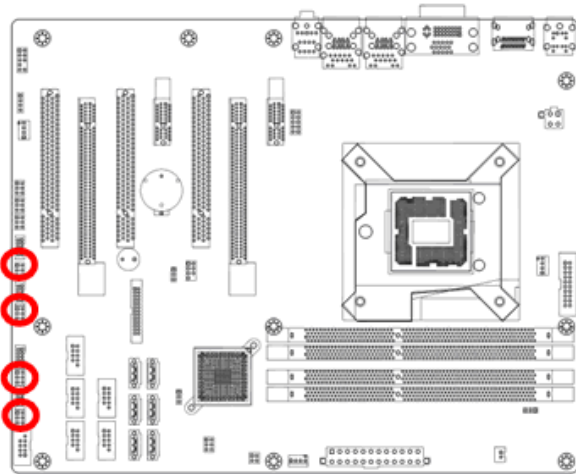

1.11.4 ATX/AT Mode Selection: PSON1

This header provides the option to boot the system in the form of ATX mode (default) or AT mode.

When the system is set in AT mode, the system power on/off will be controlled directly by the power switch on power supply. And some of the power saving modes will not function as ATX mode provided.

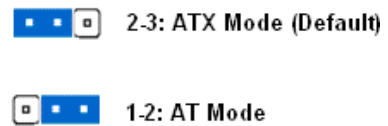
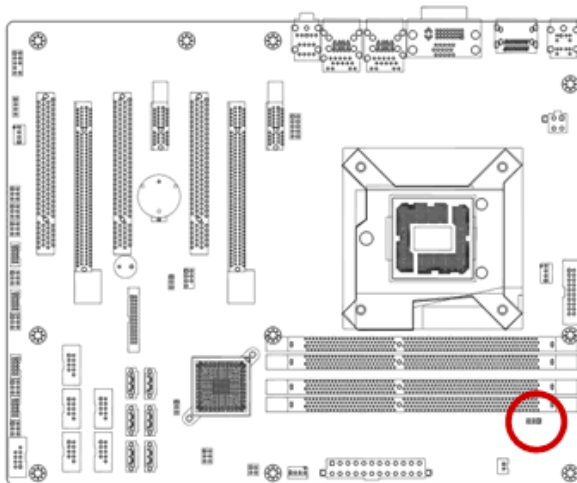

1.12 The Expansion Slots

In the future, you may need to install expansion cards. The following sub-sections describe the expansion slots and the expansion cards that they support.



Make sure to unplug the power cord before adding or removing expansion cards. Failure to do so may cause you physical injury and damage mainboard components.

1.12.1 Installation of Expansion Card

To install an expansion Card:

1. Before install the expansion card, read the documentation that came with it and make the necessary hardware setting for the card.
2. Remove the chassis cover (if the mainboard is installed in a chassis).
3. Remove the expansion slot bracket from the chassis on the slot that you intend to use. Keep the screw for later use.
4. Align the card connector with the slot and press it firmly until the card is completely seated on the slot.
5. Secure the card to the chassis with the screw that have been removed earlier (in step 3).
6. Place the chassis cover back on.

1.12.2 Setup An Expansion Card

After installing the expansion card, configure it by adjusting the software settings.

1. Turn on the system and change the BIOS settings if necessary. See Chapter 2 for information on BIOS setup.
2. Install the software drivers for the expansion card.

1.12.3 PCI (Peripheral Component Interconnect) Express Slot

The PCI Express slot supports the PCI Express interface expansion card.

- The PCI Express x16 (PCI-E x16) supports up to 4.0GB/s transfer rate.
- The PCI Express x8 (PCI-E x8) supports up to 2.0GB/s transfer rate.
- The PCI Express x4 (PCI-E x4) supports up to 1.0GB/s transfer rate.
- The PCI Express x1 (PCI-E x1) supports up to 250MB/s transfer rate.

1.12.3.1 PCI-E x 16 Slot: PCIEX16

The PCIEX16 slot supports PCI-E x16 graphic card.

- When PCIEX16 slot installed with PCI-E x16 graphic card, there will be no video output from onboard Displayport, VGA, DVI ports.

1.12.3.2 PCI-E x 4 Slot: PCIEX4_1

The PCIEX4_1 slot supports PCI-E transfer rate up to 4x ONLY.

- When PCIEX4_1 slot installed with PCI-E x4 or PCI-E x1 graphic card, there will be no video output from onboard Displayport, VGA, DVI ports.
- When the PCI-E x16 graphic card is installed on PCIEX4_1 slot, since its maximum PCI-E transfer rate is up to 4x, its performance won't be as fast as the same graphic card installed on PCIEX16 slot.
- When install two PCI-E x16 graphic cards on PCIEX4_1 and PCIEX16 slots, it is recommended to use the same model of PCI-E x16 graphic cards.



1.12.3.3 PCI-E x1 Slot: PCIEX1_1, PCIEX1_2

This slot supports PCI-E x1 cards.

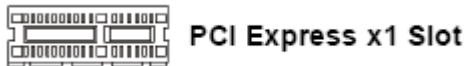

1.12.3.4 PCI Slots: PCI1, PCI2, PCI3

The PCI slot supports LAN card, SCSI card, USB card, and other add-on cards that comply with PCI specifications.

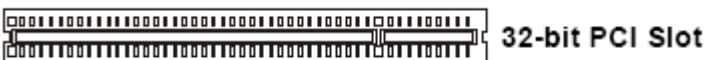

1. When adding or removing expansion cards, make sure the system power is OFF.
2. After the card is installed on the system, make the adjustments under system BIOS if necessary, then install the card driver provided by the card vendor under system OS.
3. When using PCI cards on shared slots, ensure that the card driver support "Share IRQ" or the PCI cards do not need IRQ assignments. Otherwise, conflicts will arise between the two PCI groups; marking the system unstable and the card inoperable.

Chapter 2: Starting Up the System

2.1 Starting Up Your System

1. After all connections are made, close your computer case cover.
2. Be sure all the switches are off, and check that the power supply input voltage is set to the local voltage, usually in-put voltage is 220V~240V or 110V~120V depending on your country's voltage used.
3. Connect the power supply cord into the power supply located on the back of your system case according to your system user's manual.
4. Turn on your peripheral in following order:
 - a. Your monitor.
 - b. Other external peripheral (Printer, Scanner, External Modem etc...)
 - c. Your system power. For ATX power supplies, you need to turn on the power supply and press the ATX power switch on the front side of the case.
5. The power LED on the front panel of the system case will light. The LED on the monitor may light up or switch between orange and green after the system is on. If it complies with green standards or if it is has a power standby feature. The system will then run power-on test. While the test are running, the BIOS will alarm beeps or additional message will appear on the screen.

If you do not see any thing within 30 seconds from the time you turn on the power. The system may have failed on power-on test. Recheck your jumper settings and connections or call your retailer for assistance.

Beep	Meaning
One short beep when displaying logo	No error during POST
Long beeps in an endless loop	No DRAM install or detected
One long beep followed by three short beeps	Video card not found or video card memory bad
High frequency beeps when system is working	CPU overheated System running at a lower frequency

6. During power-on, press key to enter BIOS setup. Follow the instructions in BIOS SETUP.
7. If you wish to boot from a different bootable device other than the default arrangement under the BIOS, you may press <F11> key during the system power-on (post); a menu with all detected bootable devices which are attached to the system will be displayed. Then you may select the desired first bootable device from this menu.

8. **Power off your computer:** You must first exit or shut down your operating system before switch off the power switch. For ATX power supply, you can press ATX power switching after exiting or shutting down your operating system. If you use Windows Operating Systems, click “**Start**” button, click “**Shut down**” and then click “**Shut down the computer**” The power supply should turn off after windows shut down.

Chapter 3: BIOS Setup

Warning: Before flashing the BIOS, please be sure to make the following adjustments on the system:

1. **Fully disabled the iAMT feature (through Intel ME management utility during system post).**
2. **Flash the mainboard with memory module installed on memory slot “DIMMB2” ONLY. No memory module occupied on memory slots “DIMMA1”, “DIMMA2” and “DIMMB1” during the BIOS flash process.**
3. **After the BIOS is flashed, shut down the system.**
4. **Disconnect all power connections from power supply to the mainboard.**
5. **Clear the CMOS (For at least 30 seconds).**
6. **Install the memory module(s) to the desired memory slot(s).**
7. **Reconnect all power connections from power supply to the mainboard.**
8. **When the system is booting at first time after the new BIOS is flashed, it is recommended to enter the BIOS; load the option “Load Optimized Defaults”, and then “Save and Exit Setup”.**



IF ANY OF THE ABOVE STEPS IS NOT FOLLOWED, IT MAY CAUSE THE FLASHED BIOS NOT FUNCTION PROPERLY.

3.1 Introducing BIOS

The BIOS is a program located on a Flash Memory on the motherboard. This program is a bridge between motherboard and operating system. When you start the computer, the BIOS program gains control. The BIOS first operates an auto-diagnostic test called POST (power on self test) for all the necessary hardware, it detects the entire hardware device and configures the parameters of the hardware synchronization. Only when these tasks are completed done it gives up control of the computer to operating system (OS). Since the BIOS is the only channel for hardware and software to communicate, it is the key factor for system stability, and in ensuring that your system performance as its best.

In the BIOS Setup main menu of Figure 3-1, you can see several options. We will explain these options step by step in the following pages of this chapter, but let us first see a short description of the function keys you may use here:

- Press <Esc> to quit the BIOS Setup.
- Press ↑↓←→ (up, down, left, right) to choose, in the main menu, the option you want to confirm or to modify.
- Press <F10> when you have completed the setup of BIOS parameters to save these parameters and to exit the BIOS Setup menu.

- Press Page Up/Page Down or +/- keys when you want to modify the BIOS parameters for the active option.

3.2 Entering BIOS Setup Menu

Power on the computer and by pressing immediately allows you to enter BIOS Setup Menu.

If you are not able to enter the BIOS menu but you still wish to enter Setup, restart the system to try again by turning it OFF then ON or pressing the “RESET” button on the system case. You may also restart by simultaneously pressing <Ctrl>, <Alt> and <Delete> keys.



The items under each BIOS category described in this chapter are under continuous update for better system performance. Therefore, the description may be slightly different from the latest BIOS and should be held for reference only.

3.3 Getting Help

Main Menu

The main menu lists the setup functions you can make changes to. You can use the arrow keys to select the item. The on-line description of the highlighted setup function is displayed at the bottom of the screen.

Sub- Menu

If you find a right pointer symbol (as shown in the picture below) appears to the left of certain fields that means a sub-menu can be launched from this field. A sub-menu contains additional options for a field parameter. You can use arrow keys to highlight the field and press <Enter> to call up the sub-menu. Then you can use the control keys to enter values and move from field to field within a sub-menu. If you want to return to the main menu, just press the <ESC>.

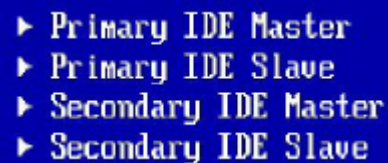

```
▶ Primary IDE Master
▶ Primary IDE Slave
▶ Secondary IDE Master
▶ Secondary IDE Slave
```

General Help <F1>

The BIOS setup program provides a General Help screen. You can call up this screen from any menu by simply pressing <F1>. The Help screen lists the appropriate keys to use and the possible selections for the highlighted item. Press <Esc> to exit the Help screen.

3.4 BIOS Menu Screen

When entering the BIOS, the following screen appears. The BIOS menu screen displays the items that allow user to make changes to the system configuration. To access the menu items, press the up/down/right/left arrow key on the keyboard until the desired item is highlighted, then press [Enter] to access the specific menu.

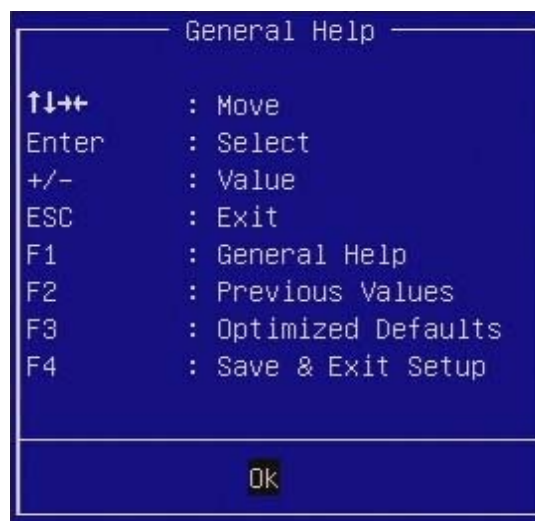
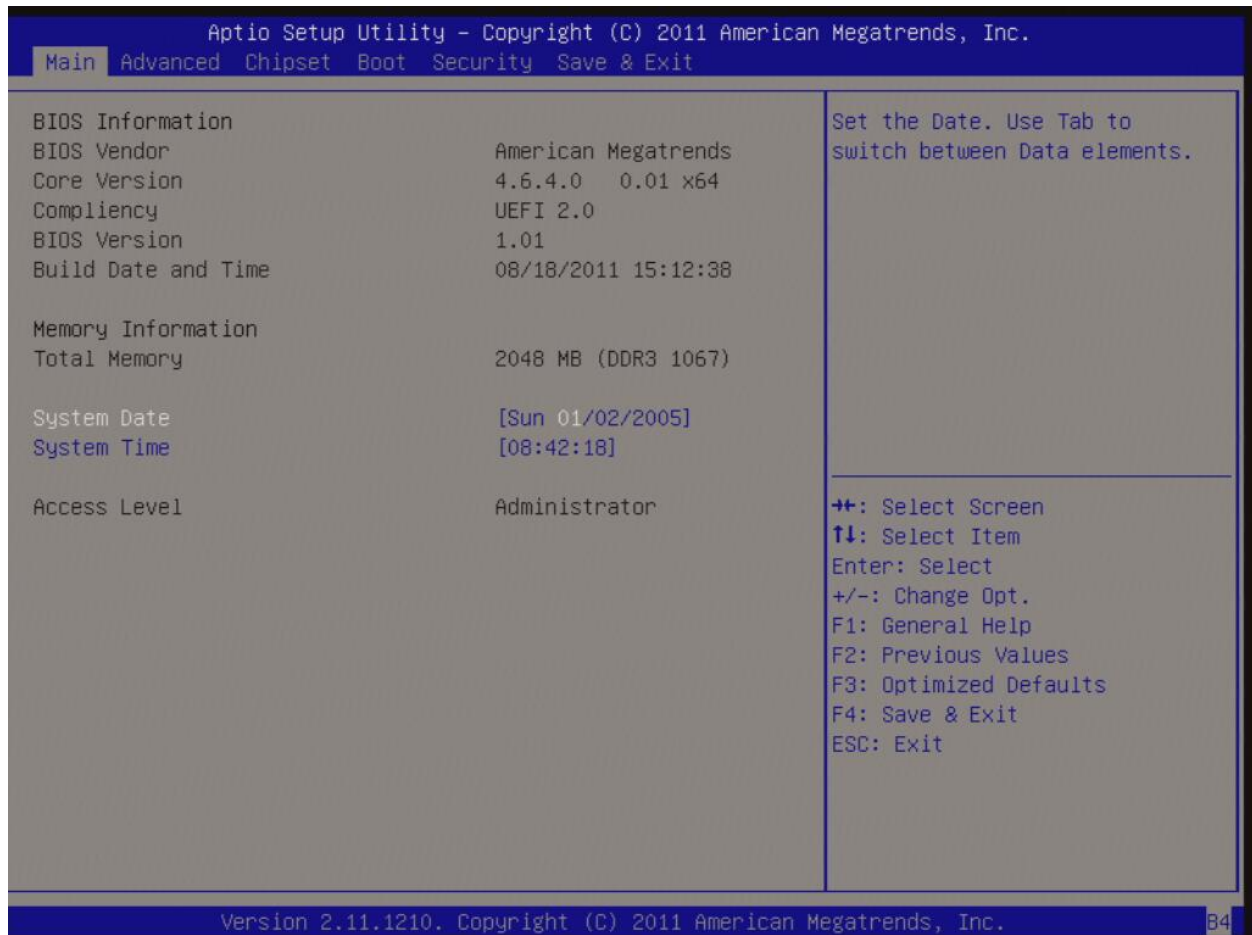

3.5 Main Menu

This menu gives user an overview of the general system specifications. The BIOS automatically detects the items in this menu. This menu provides basic system information, such as installed memory size, time, date etc.

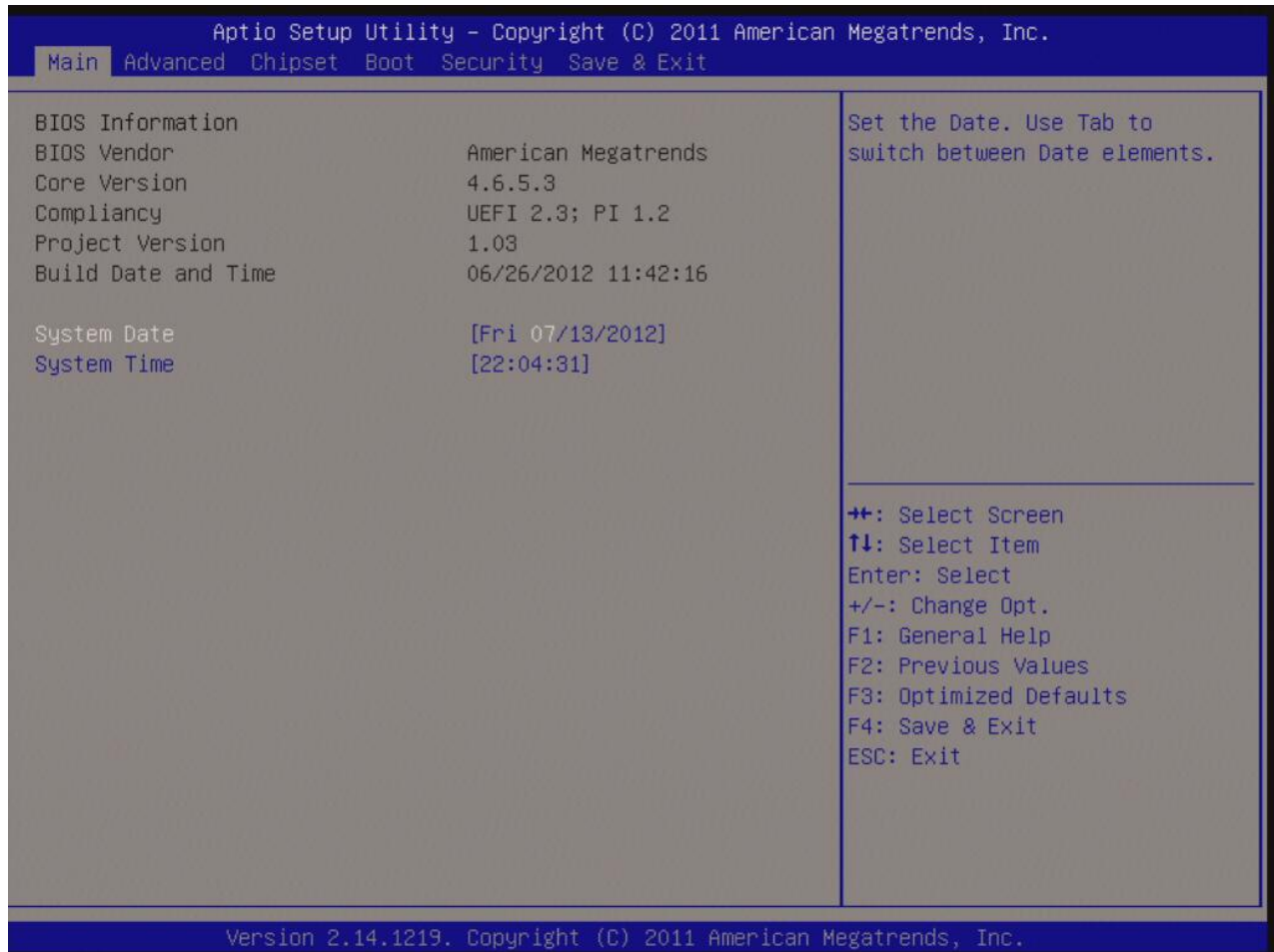

- **BIOS Information**

Displays the auto-detected BIOS information.

- **System Date**

The date format is <Date>,<Month>,<Day>,<Year>.

- **System Time**

The time format is <Hour>,<Minute>,<Second>.

3.6 Advanced Menu

Select the "Advanced" tab from the BIOS menu screen to enter the Advanced BIOS Setup screen.

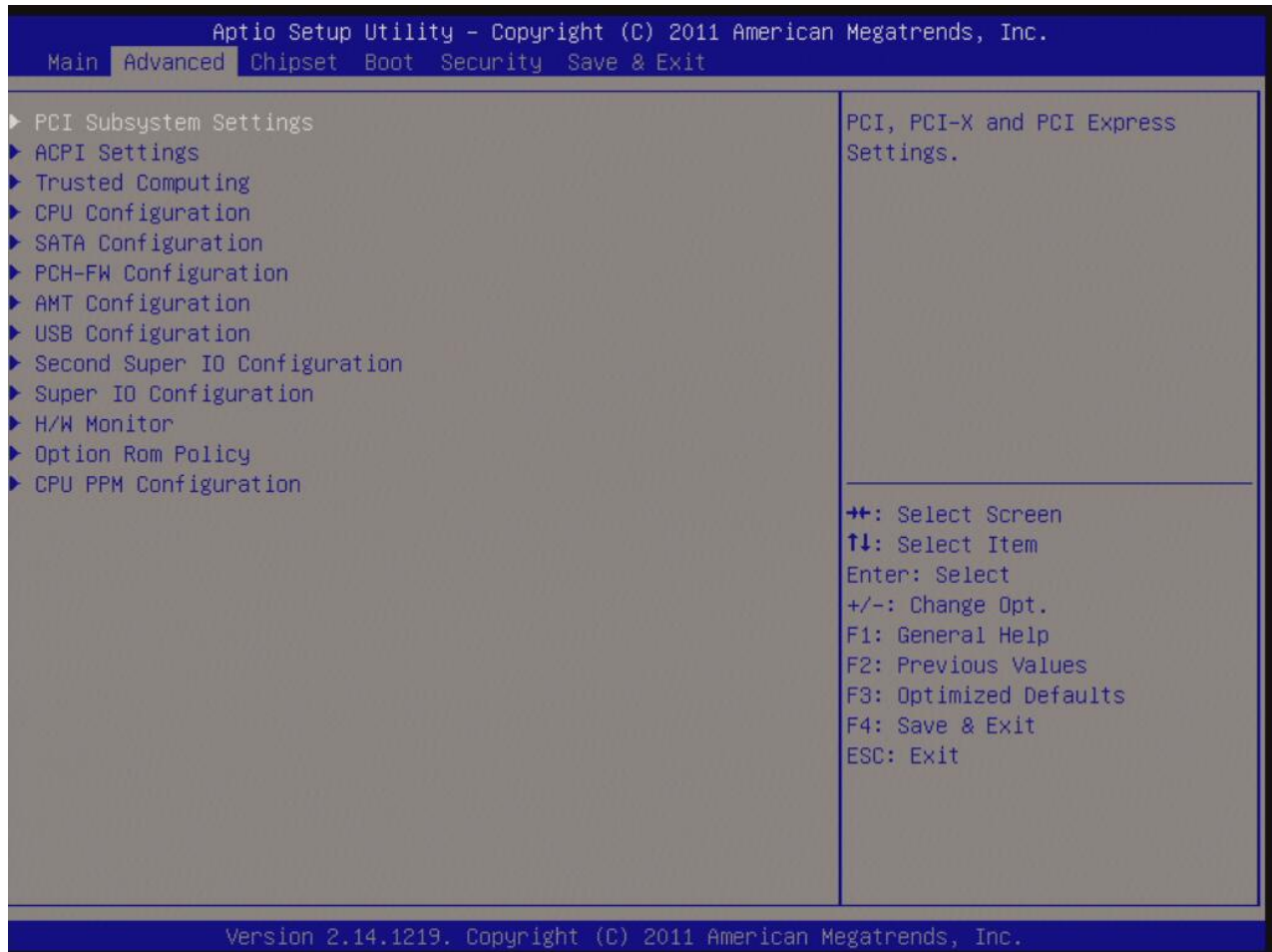

NOTE: Take caution when changing the settings of the Advanced menu items. Incorrect field values can cause the system not to function properly.

3.6.1 PCI Subsystem Setting

The PCI PnP menu items allow you to change the advanced settings for PCI/PnP devices. This menu includes setting IRQ and DMA channel resources for either PCI/PnP or legacy ISA devices, and setting the memory size block for legacy ISA devices.

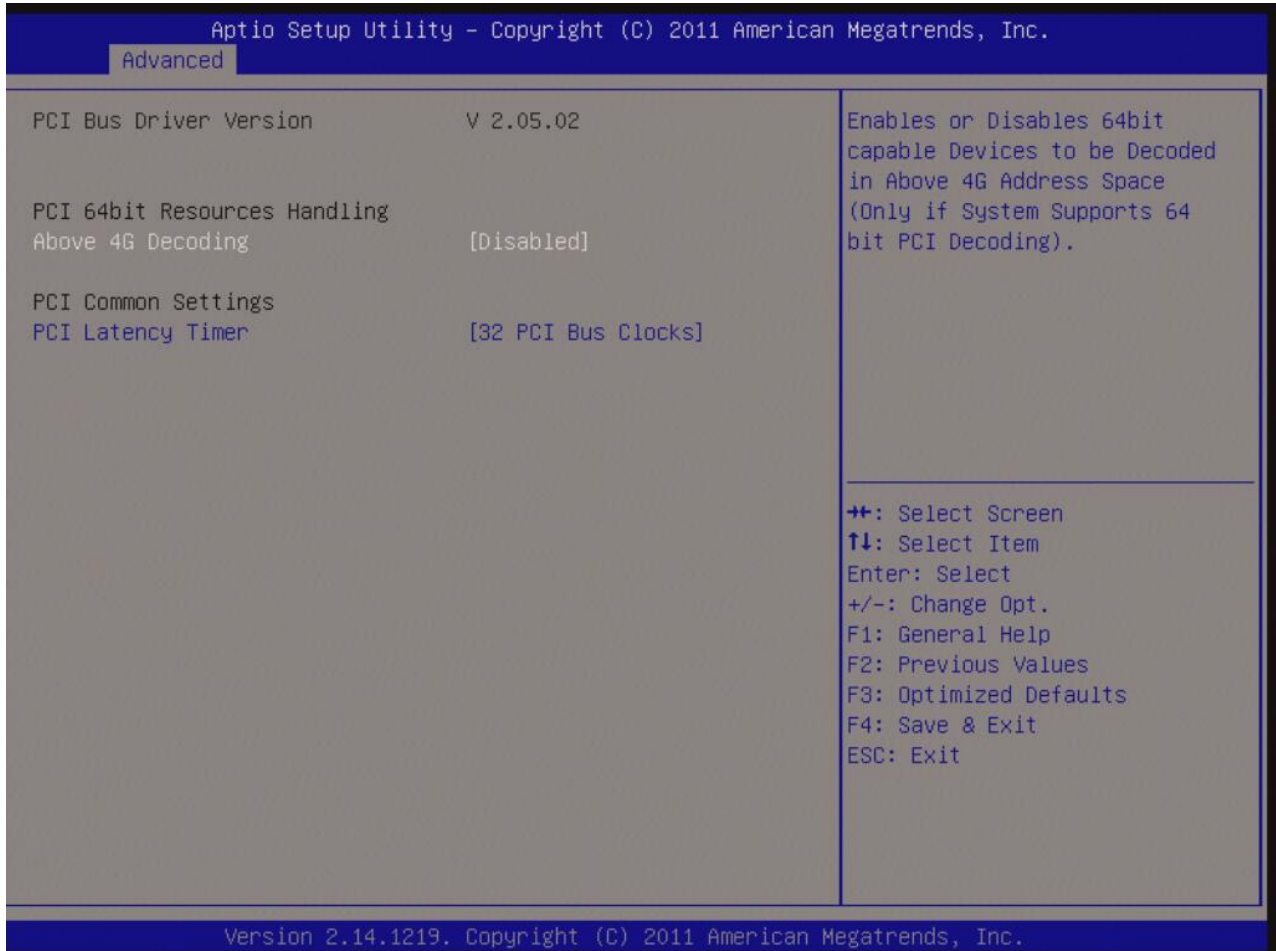

- **PCI Bus Driver Version**

Displays the information of PCI Bus Driver Version

- **PCI Latency Timer [32 PCI Bus Clocks]**

Allows the PCI Latency Timer to be adjusted. This option sets the latency of all PCI devices on the PCI bus.

Configuration options: [32 PCI Bus Clocks], [64 PCI Bus Clocks], [96 PCI Bus Clocks], [128 PCI Bus Clocks], [160 PCI Bus Clocks], [192 PCI Bus Clocks], [224 PCI Bus Clocks], [248 PCI Bus Clocks]

3.6.2 ACPI Settings

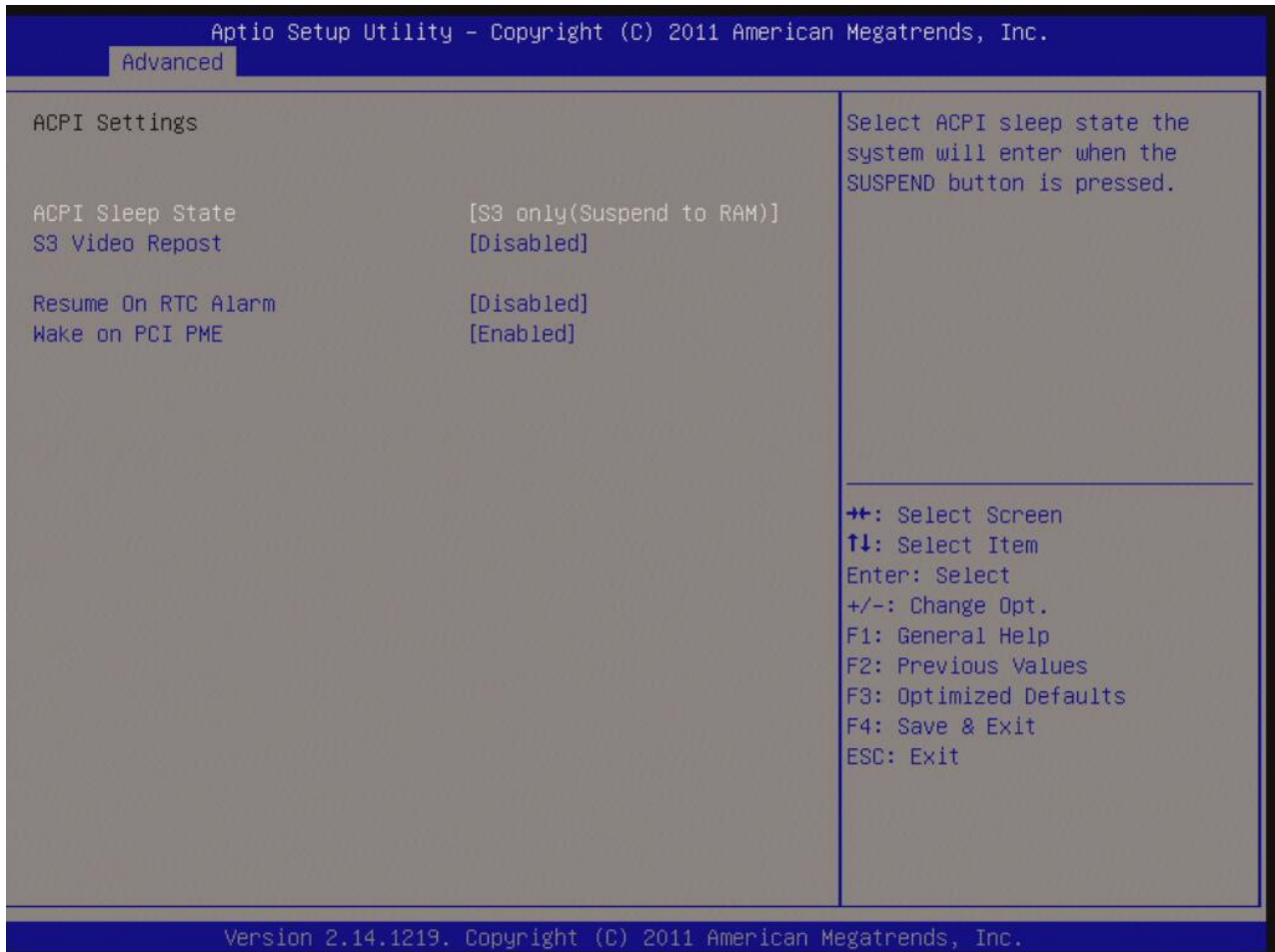

- **ACPI Sleep State [S3 (suspend to RAM)]**

Select the highest ACPI sleep state the system will enter the SUSPEND button is press.

Configuration options: [Suspend Disabled], [S1 (CPU Stop Clock)], [S3 (suspend to RAM)]

- **S3 Video Repost**

Allows you to determine whether to invoke VGA BIOS POST on S3/STR resume.

Configuration options: [Disabled] [Enabled]

- **Resume On RTC Alarm [Disabled]**

Enable or disable system wake on alarm even. When enabled, system will wake upon the hr/min/sec specified.

Configuration options: [Disabled], [Enabled]

- **Wake on PCI PME**

Configuration options: [Disabled] [Enabled]

3.6.3 Trusted Computing

Trusted computing (TPM) settings.

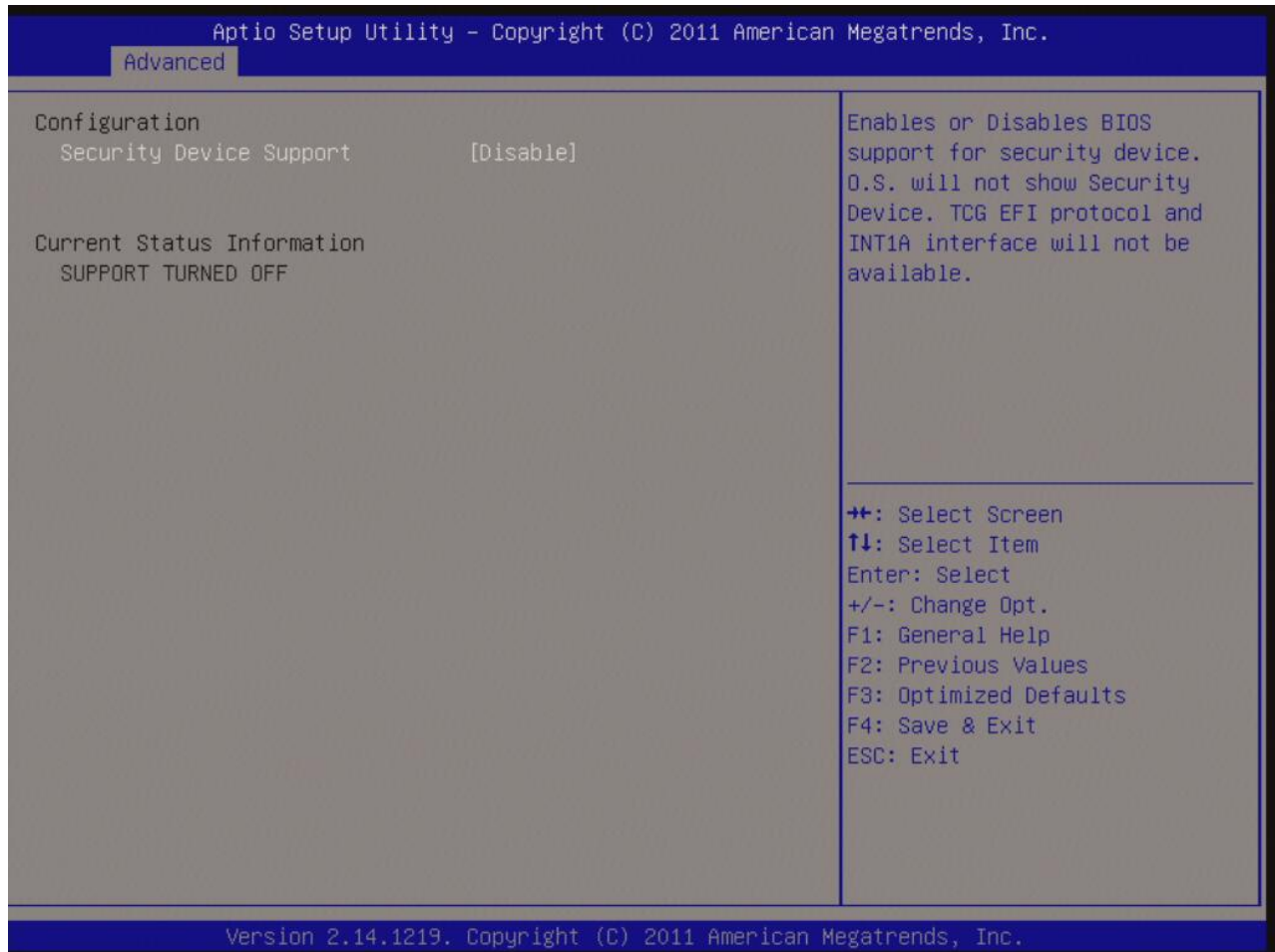

- **Security Device Support [Disabled]**

Enable or disable TPM support.

Configuration options: [Disabled], [Enabled]

- **Current Status Information**

Displays the TPM status information [SUPPORT TURNED OFF]

3.6.4 CPU Configuration

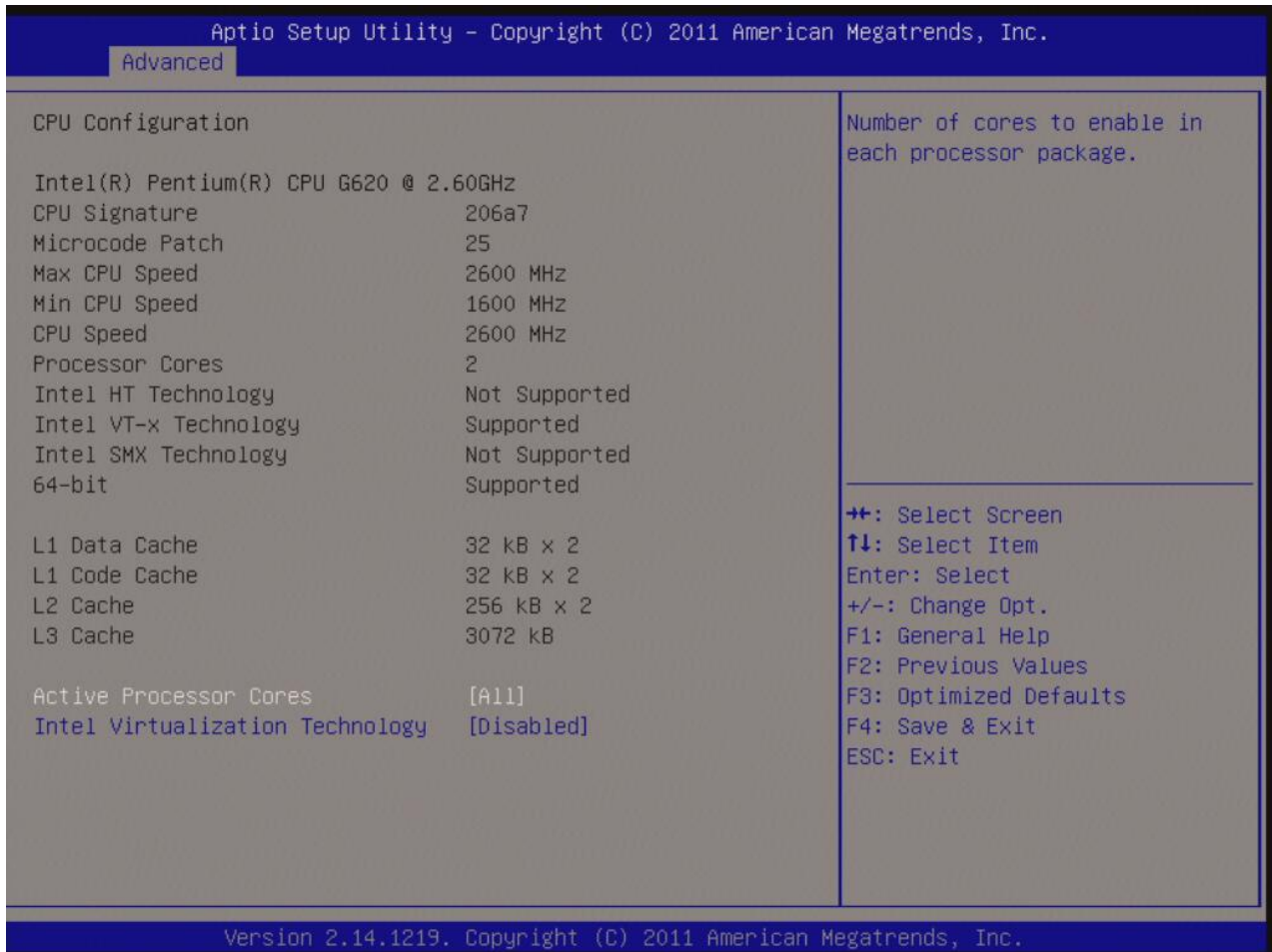

- **CPU configuration**

Displays the CPU information

- **Active Processor Cores [All]**

Select the numbers of cores in each processor package.

Configuration options: [All], [1], [2], [3], [4], [5], [6], [7]



NOTE: The availability of options depends on the type of CPU installed.

- **Intel Virtualization Technology[Disabled]**

When enable, a VMM can utilize the additional hardware capabilities provided by Vanderpool Technology.

Configuration options: [Disabled], [Enabled]

3.6.5 SATA Configuration

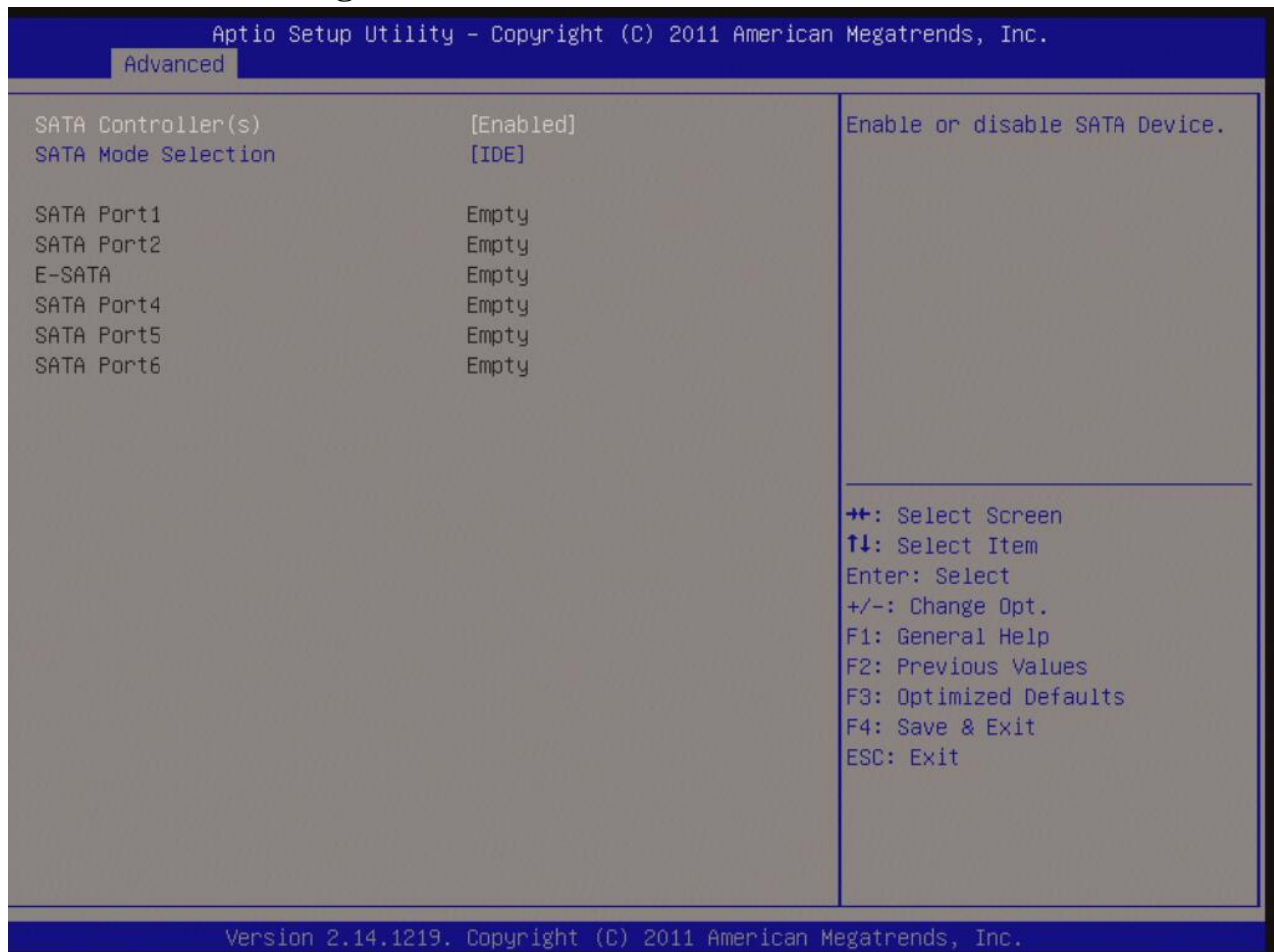

- **SATA Controller(s) [Enabled]**

Enabled/Disabled Serial ATA Controller.

Configuration options: [Disabled], [Enabled]

- **SATA Mode [IDE]**

Support IDE, AHCI or RAID mode

Configuration options: [IDE], [AHCI], [RAID]

3.6.6 PCH-FW Configuration

Intel ME Configuration

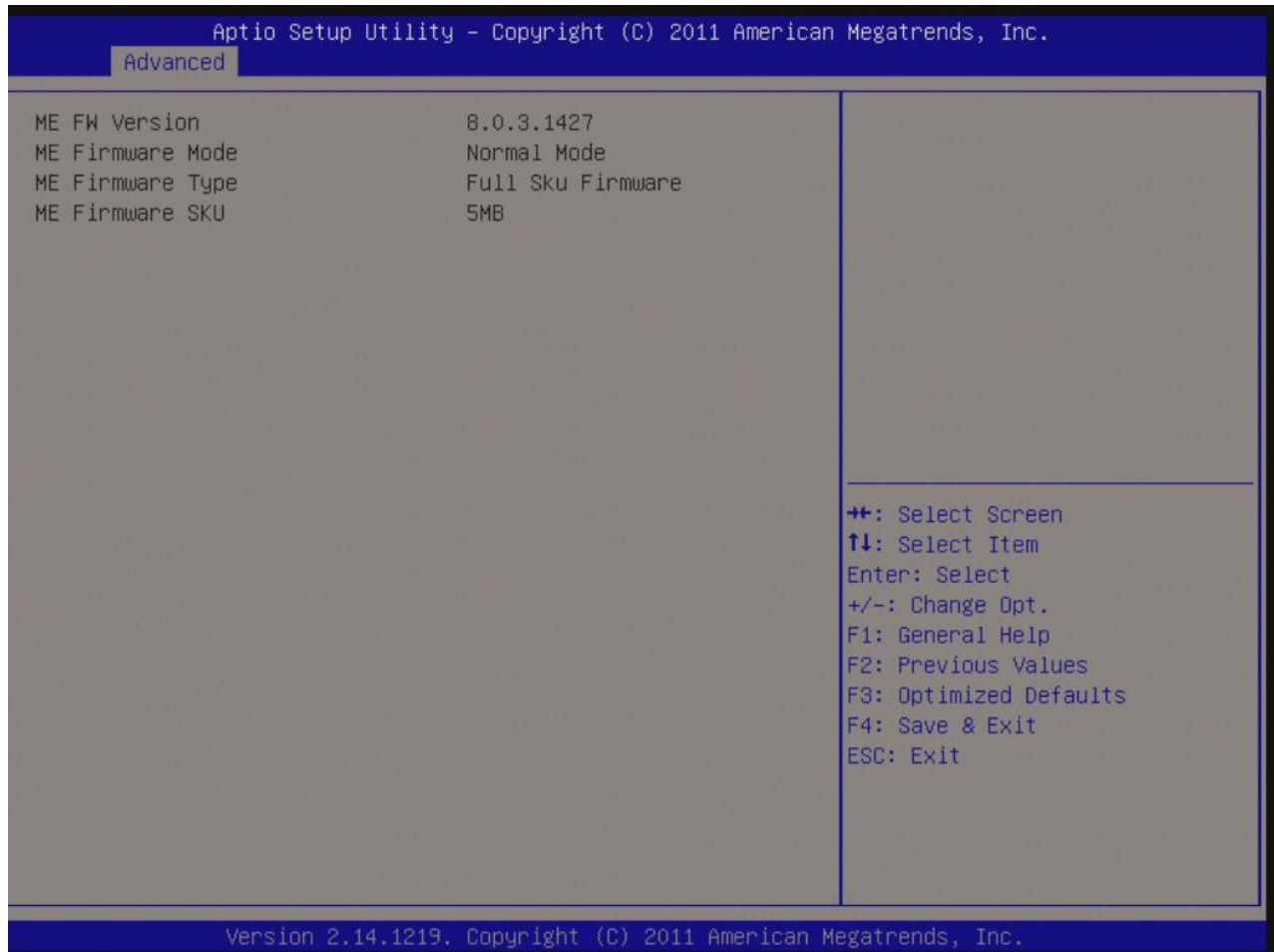

3.6.7 AMT Configuration

AMT Configuration Parameters

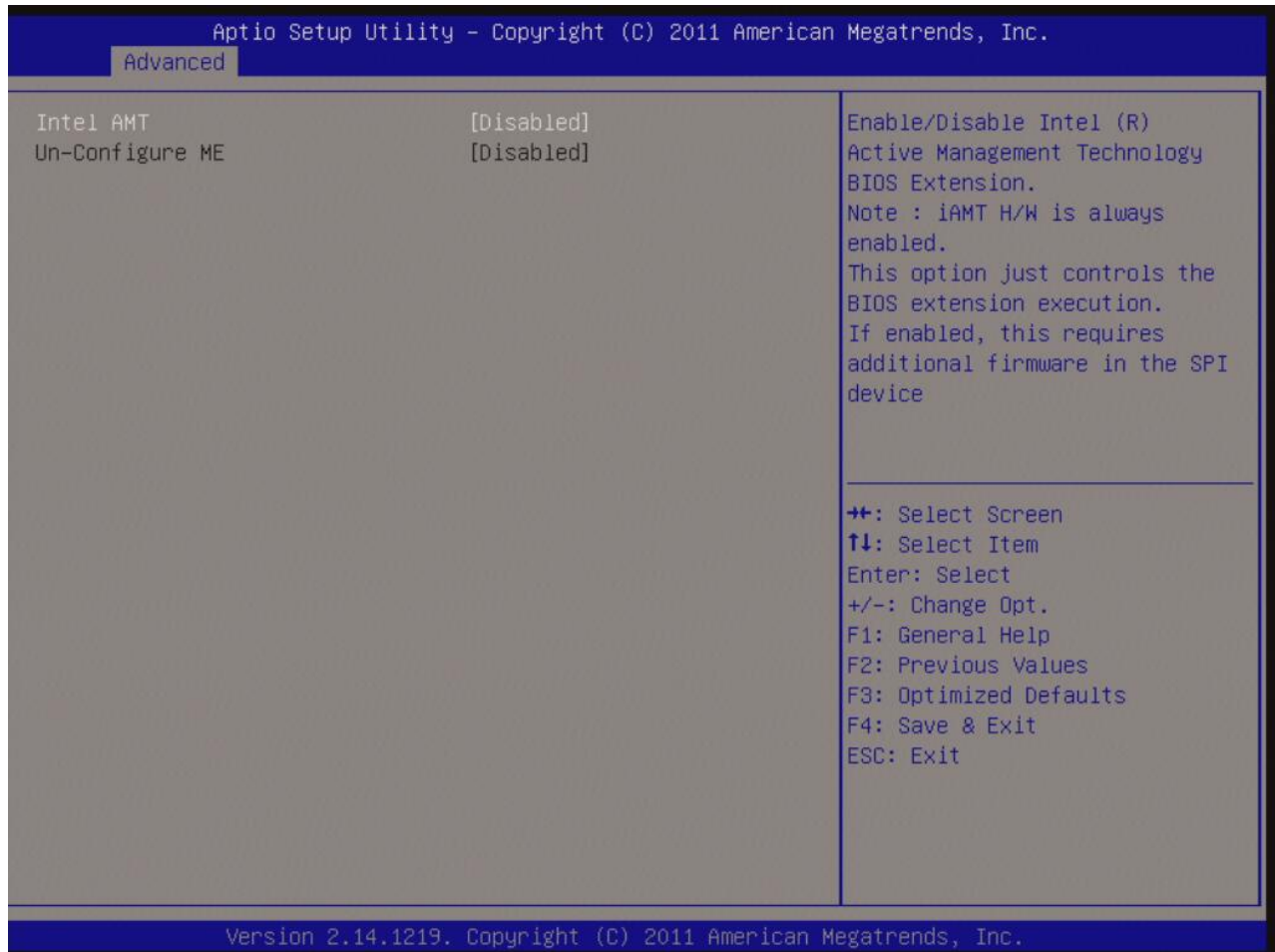

- **Intel AMT [Disabled]**

Enable/Disable access to Intel AMT extension ROM menu during system post.

Configuration options: [Disabled], [Enabled]

- **Un-configure ME [Disabled]**

Use this item to enable/ disable un-configure ME without password.

Configuration options: [Disabled], [Enabled]

3.6.8 USB Configuration

USB Configuration Parameters

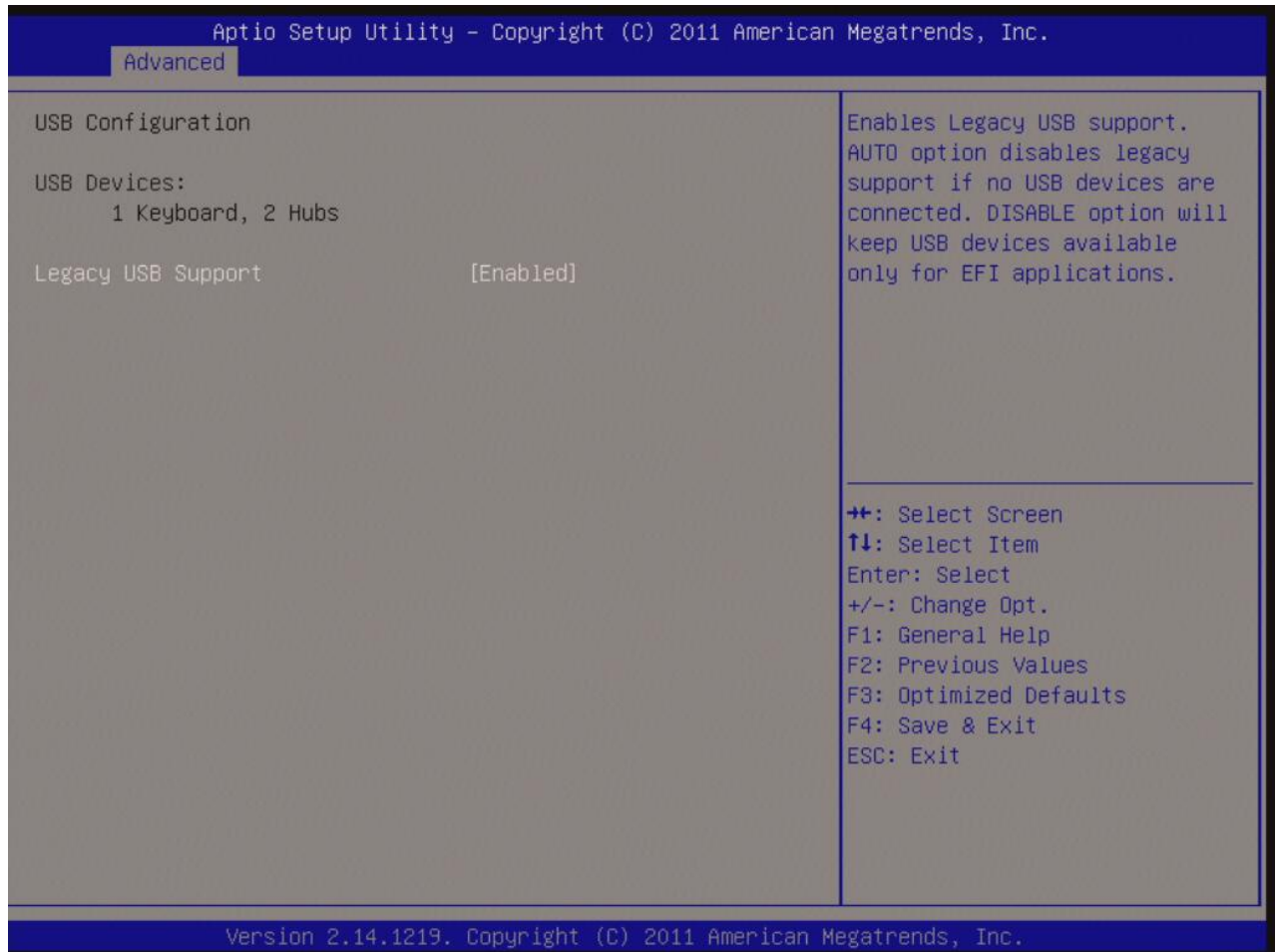

- **USB Device**

Display how many devices are connected.

- **Legacy USB Support [Enabled]**

Enables Legacy USB support. "AUTO" option disabled legacy support if no USB device is connected.

"Disabled" option will keep USB devices available only for EFI applications.

Configuration options: [Enabled], [Disabled], [Auto]

3.6.9 Second Super IO Configuration

System Super IO Chip Parameters

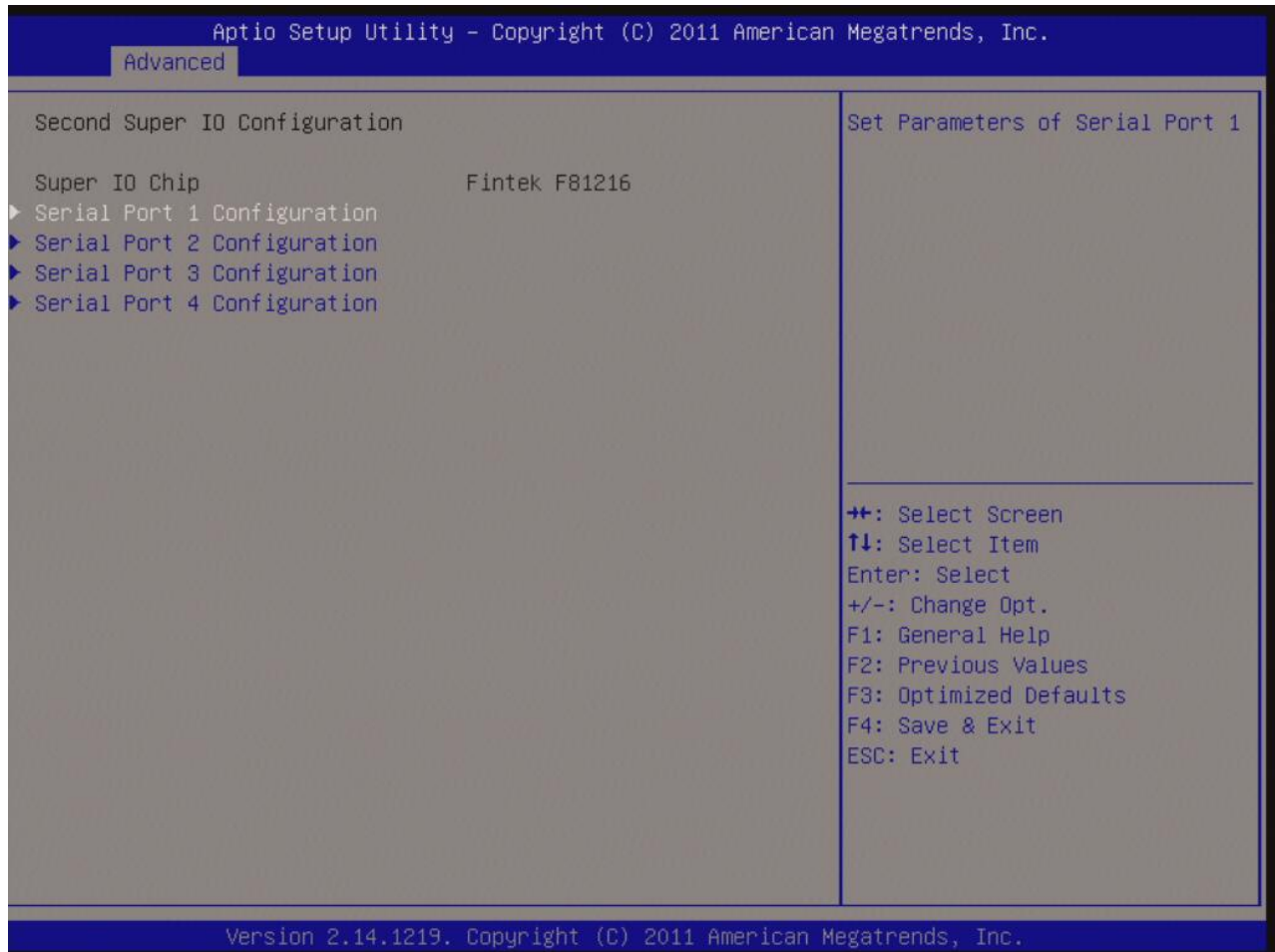

Super IO Configuration

Super IO Chip [Fintek F81216]

3.6.9.1 Serial Port 1 Configuration

Set Parameters of Serial Port 1

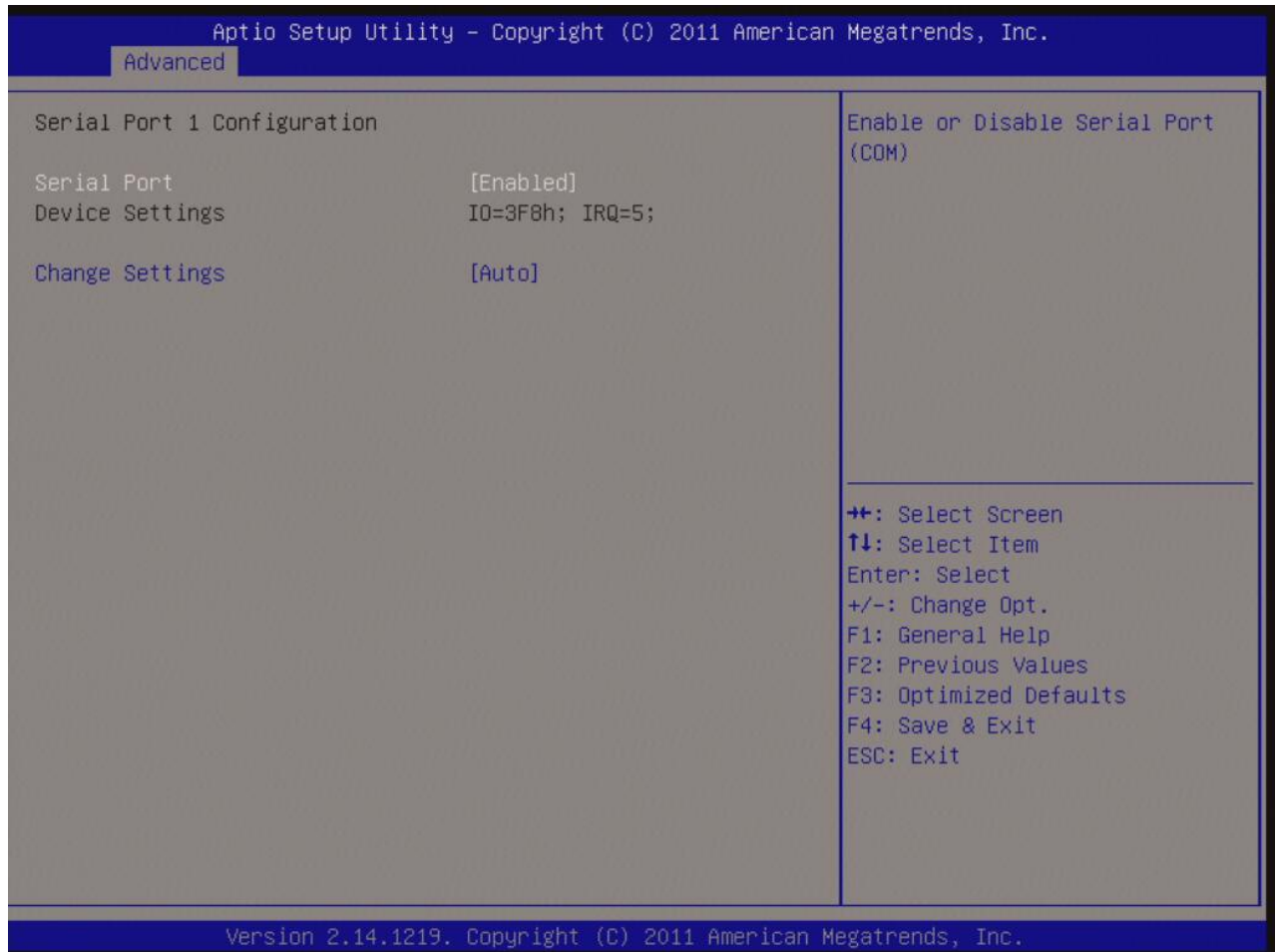

Serial Port 1 Configuration

- **Serial Port [Enable]**

Enable or Disable Serial Port.

Configuration options: [Disabled], [Enabled]

- **Device Setting [IO=3F8h; IRQ=4]**

- **Change Setting[Auto]**

Select an optimal setting for Super IO device.

Configuration options: [Auto], [IO=3F8h; IRQ=4], [IO=3F8h; IRQ=3, 4, 5, 6, 7, 9, 10, 11, 12], [IO=2F8h; IRQ=3, 4, 5, 6, 7, 9, 10, 11, 12], [IO=3E8h; IRQ=3, 4, 5, 6, 7, 9, 10, 11, 12], [IO=2E8h; IRQ=3, 4, 5, 6, 7, 9, 10, 11, 12]

3.6.9.2 Serial Port 2 Configuration

Set Parameters of Serial Port 2

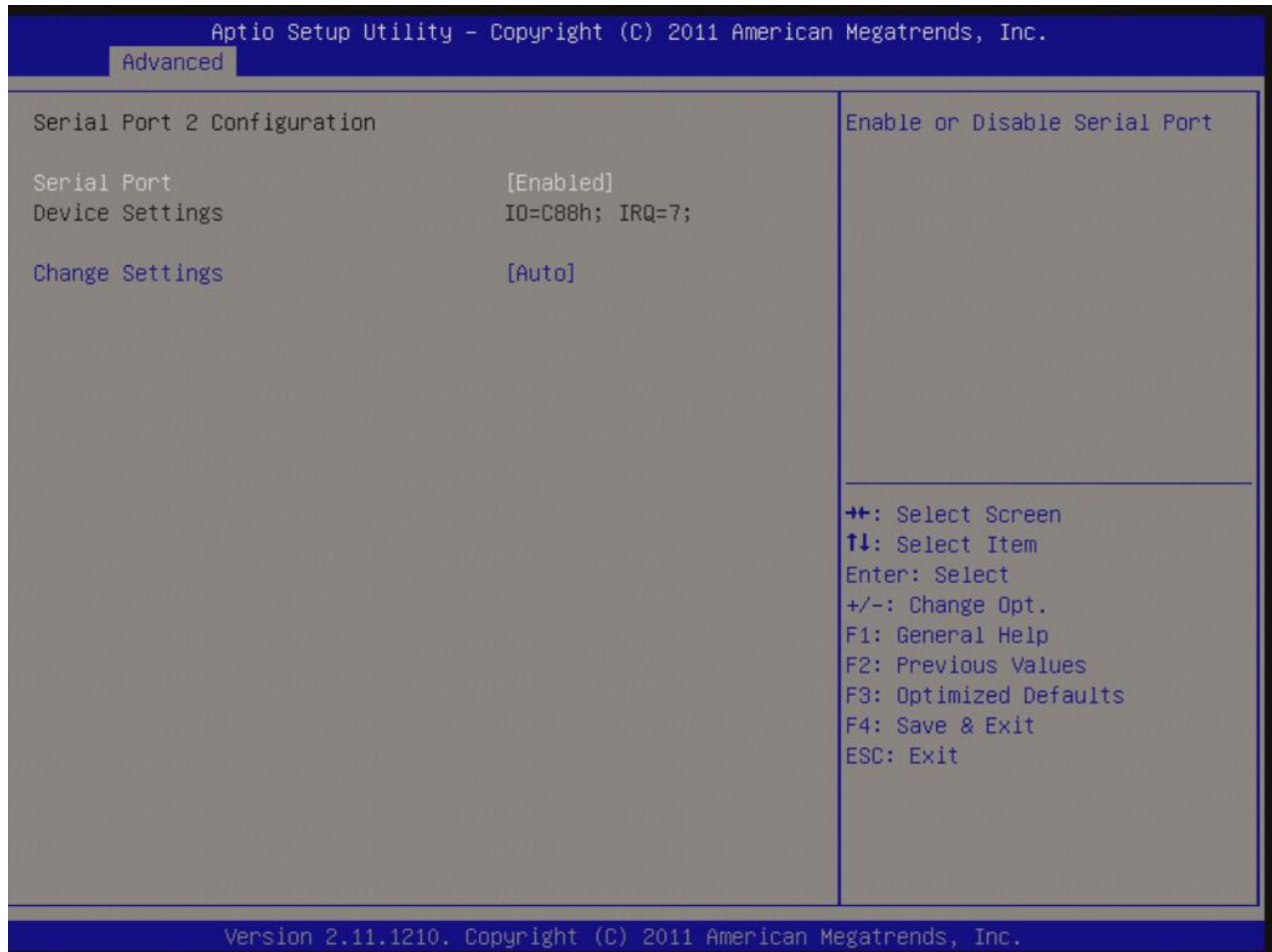

Serial Port 2 Configuration

- **Serial Port [Enabled]**

Enable or Disable Serial Port.

Configuration options: [Disabled], [Enabled]

- **Device Setting [IO=2F8h; IRQ=3]**

- **Change Setting[Auto]**

Select an optimal setting for Super IO device.

Configuration options: [Auto], [IO=2F8h; IRQ=3], [IO=3F8h; IRQ=3, 4, 5, 6, 7, 9, 10, 11, 12], [IO=2F8h; IRQ= 3, 4, 5, 6, 7, 9, 10, 11, 12], [IO= 3E8h; IRQ= 3, 4, 5, 6, 7, 9, 10, 11, 12], [IO=2E8h; IRQ= 4, 5, 6, 7, 9, 10, 11, 12]

3.6.9.3 Serial Port 3 Configuration

Set Parameters of Serial Port 3

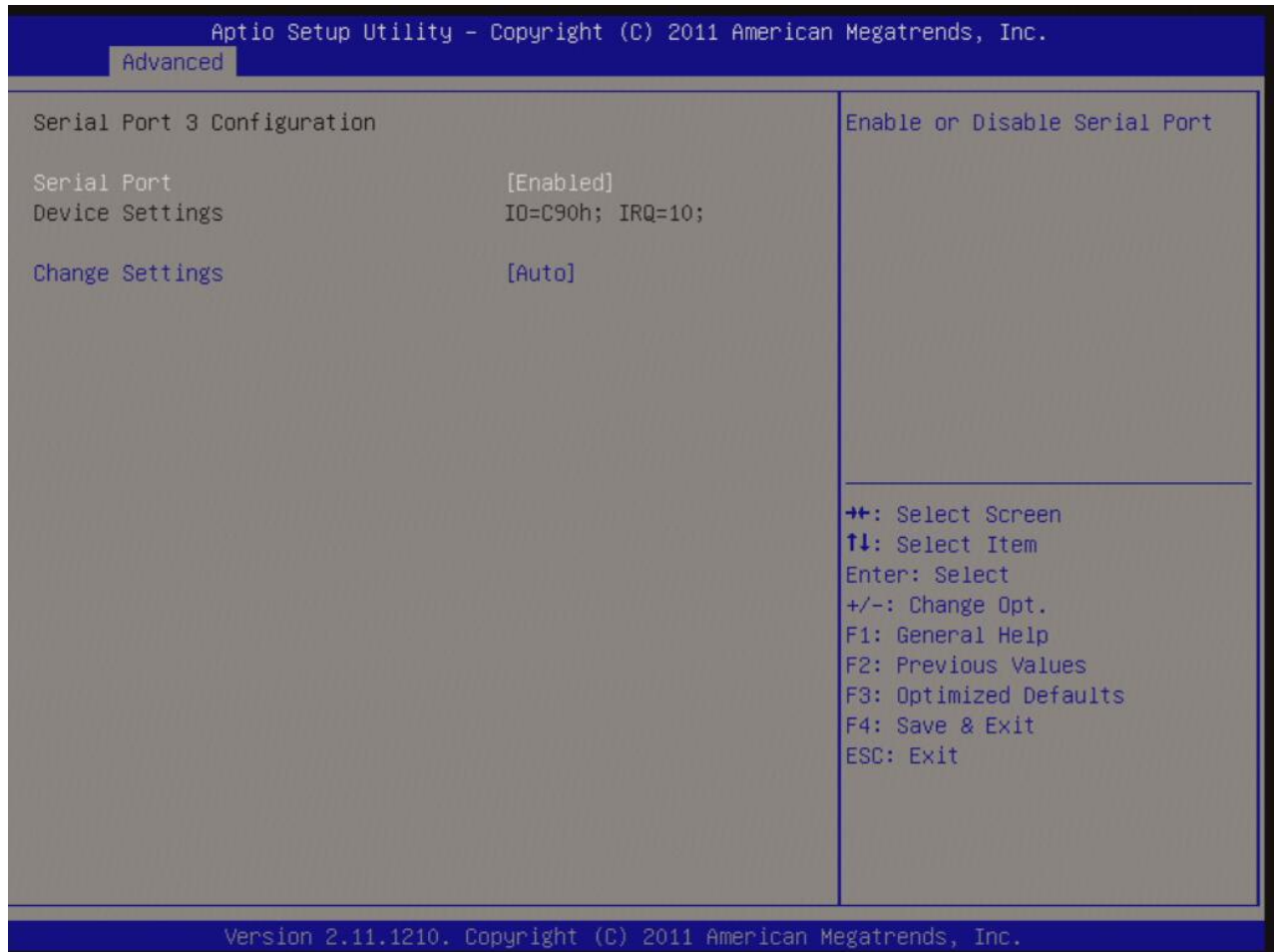

Serial Port 3 Configuration

- **Serial Port [Enabled]**

Enable or Disable Serial Port.

Configuration options: [Disabled], [Enabled]

- **Device Setting [IO=C80h; IRQ=5]**

- **Change Setting[Auto]**

Select an optimal setting for Super IO device.

Configuration options: [Auto], [Auto] [IO=C80h; IRQ=5], [IO=C80h; IRQ=5, 7, 9, 10, 11], [IO=C88h; IRQ=5, 7, 9, 10, 11], [IO=C90h; IRQ=5, 7, 9, 10, 11], [IO=C98h; IRQ=5, 7, 9, 10, 11]

3.6.9.4 Serial Port 4 Configuration

Set Parameters of Serial Port 4

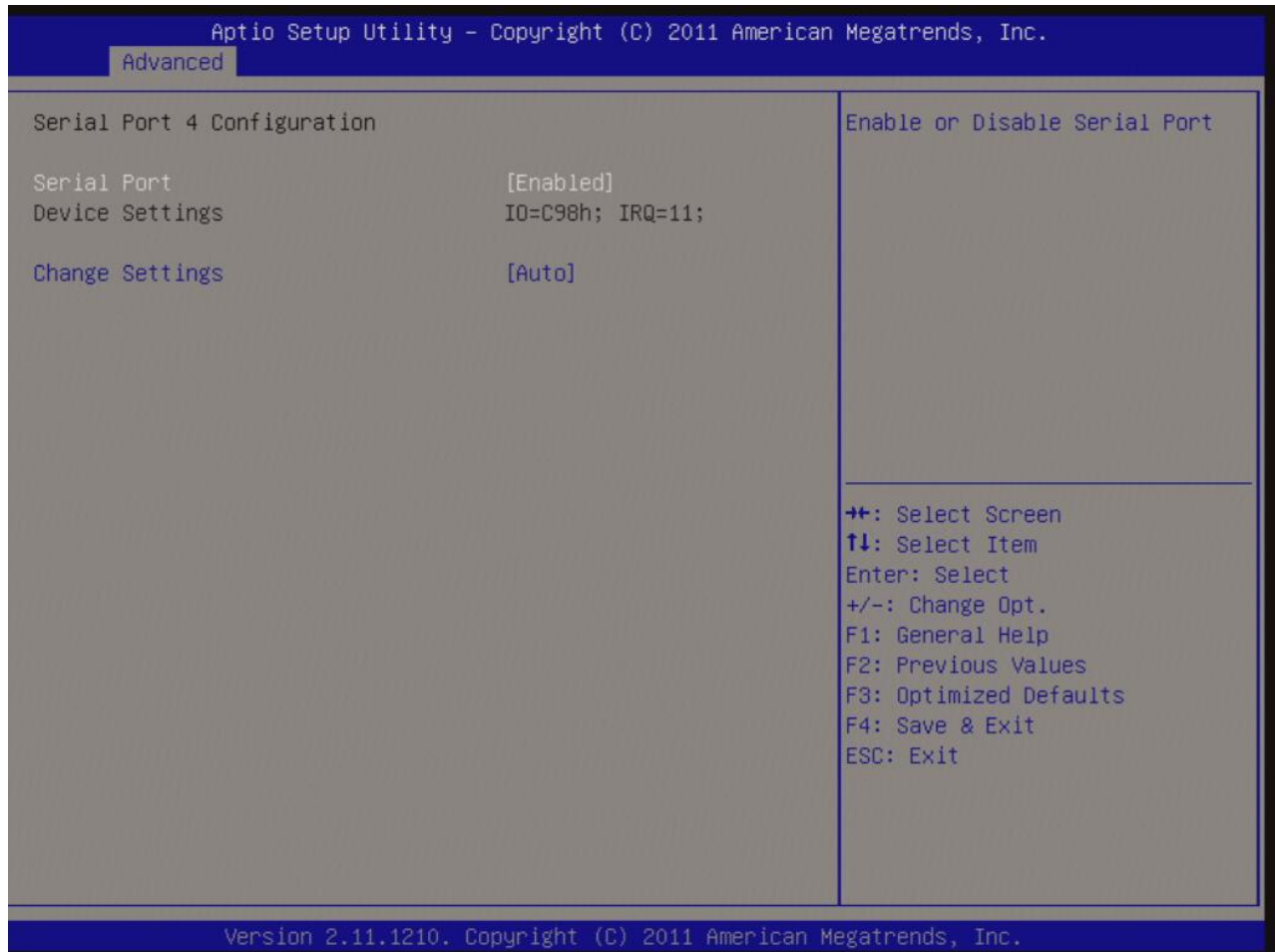

Serial Port 4 Configuration

- **Serial Port [Enabled]**

Enable or Disable Serial Port.

Configuration options: [Disabled], [Enabled]

- **Device Setting [IO=C88h; IRQ=5]**

- **Change Setting[Auto]**

Select an optimal setting for Super IO device.

Configuration options: [Auto], [IO=C88h; IRQ=5], [IO=C80h; IRQ=5, 7, 9, 10, 11], [IO=C88h; IRQ=5, 7, 9, 10, 11], [IO=C90h; IRQ=5, 7, 9, 10, 11], [IO=C98h; IRQ=5, 7, 9, 10, 11]

3.6.10 Parallel Port Configuration

Set Parameters of parallel Port

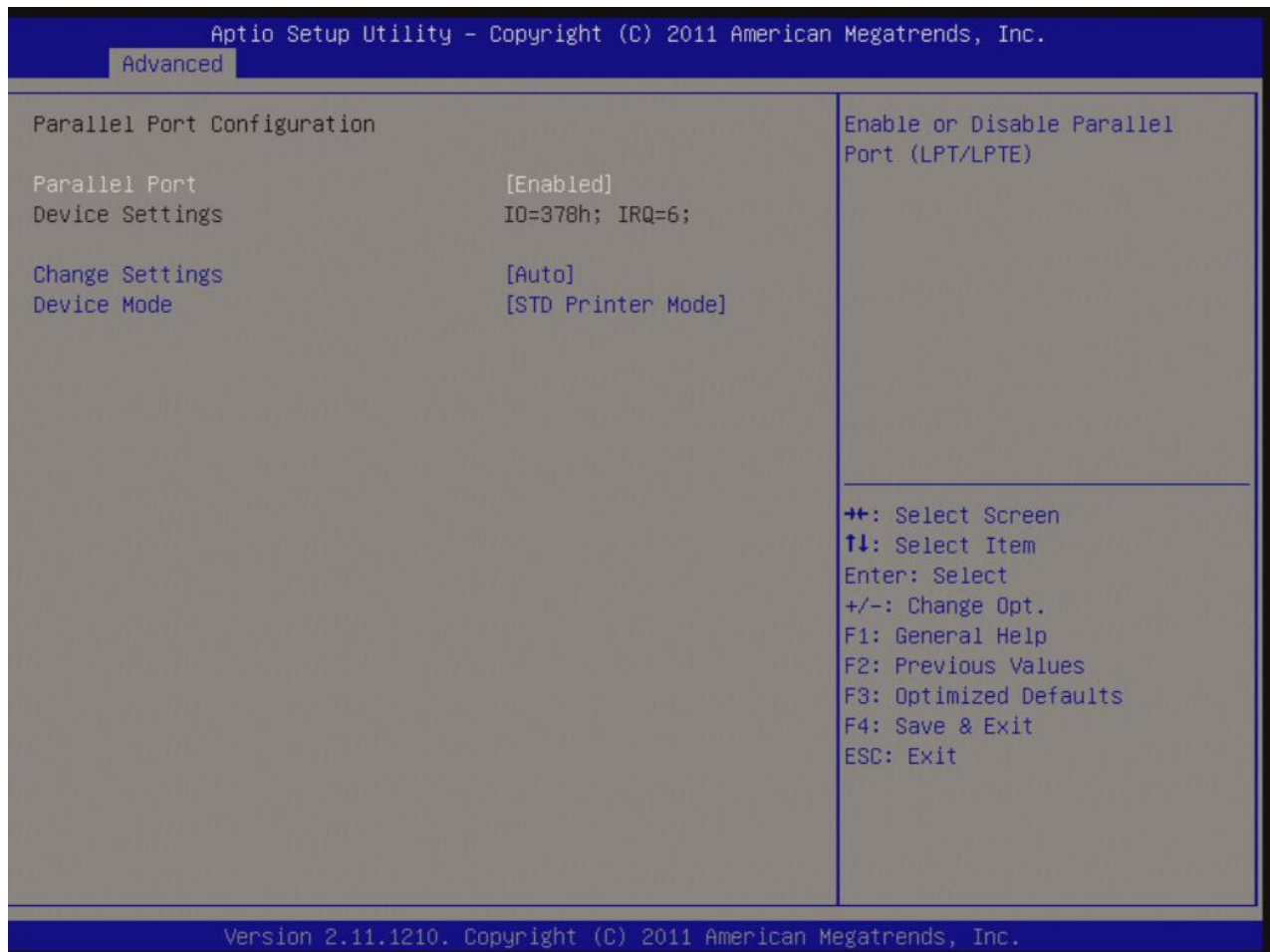

- **Parallel Port [Enable]**

Use this item to enable or disable the onboard parallel port.

Configuration options: [Disabled], [Enabled]

- **Change Settings [Auto]**

Use this item to select an optional setting for Super IO device.

Configuration Options : [Auto], [IO=378h; IRQ=7], [IO=378h; IRQ=5,6,7,9,10,11,12], [IO=278h; IRQ=5,6,7,9,10,11,12], [IO=3BCh; IRQ=5,6,7,9,10,11,12]

- **Device Mode [STD Printer Mode]**

Use this item to change the Printer Port mode.

Configuration Options : [STD Printer Mode], [SPP Mode], [EPP-1.9 and SPP Mode], [EPP-1.7 and SPP Mode], [ECP Mode], [ECP Mode and EPP-1.9 Mode], [ECP Mode and EPP-1.7 Mode]

- **Watch Dog Timer**

Use this item to enable/disable Watch Dog Timer

Configuration options: [Disabled], [Enabled]

- **Chassis Opened Warning**

Configuration options: [Disabled], [Enabled]

3.6.11 Hardware Monitor

Display system health status

Aptio Setup Utility - Copyright (C) 2011 American Megatrends, Inc.

Advanced

Pc Health Status

Smart Fan function page

Smart Fan

System temperature	: +31 C
CPU temperature	: +33 C
Chassis Fan Speed	: N/A
CPU Fan Speed	: 4873 RPM
System Fan Speed	: N/A
VCORE	: +1.056 V
+12V	: +12.032 V
+5V	: +5.054 V
5VSB	: +5.120 V
3VCC	: +3.408 V
3VSB	: +3.360 V
VBAT	: +3.088 V

++: Select Screen
↑↓: Select Item
Enter: Select
+/-: Change Opt.
F1: General Help
F2: Previous Values
F3: Optimized Defaults
F4: Save & Exit
ESC: Exit

Version 2.14.1219. Copyright (C) 2011 American Megatrends, Inc.

3.6.11.1 Smart Fan

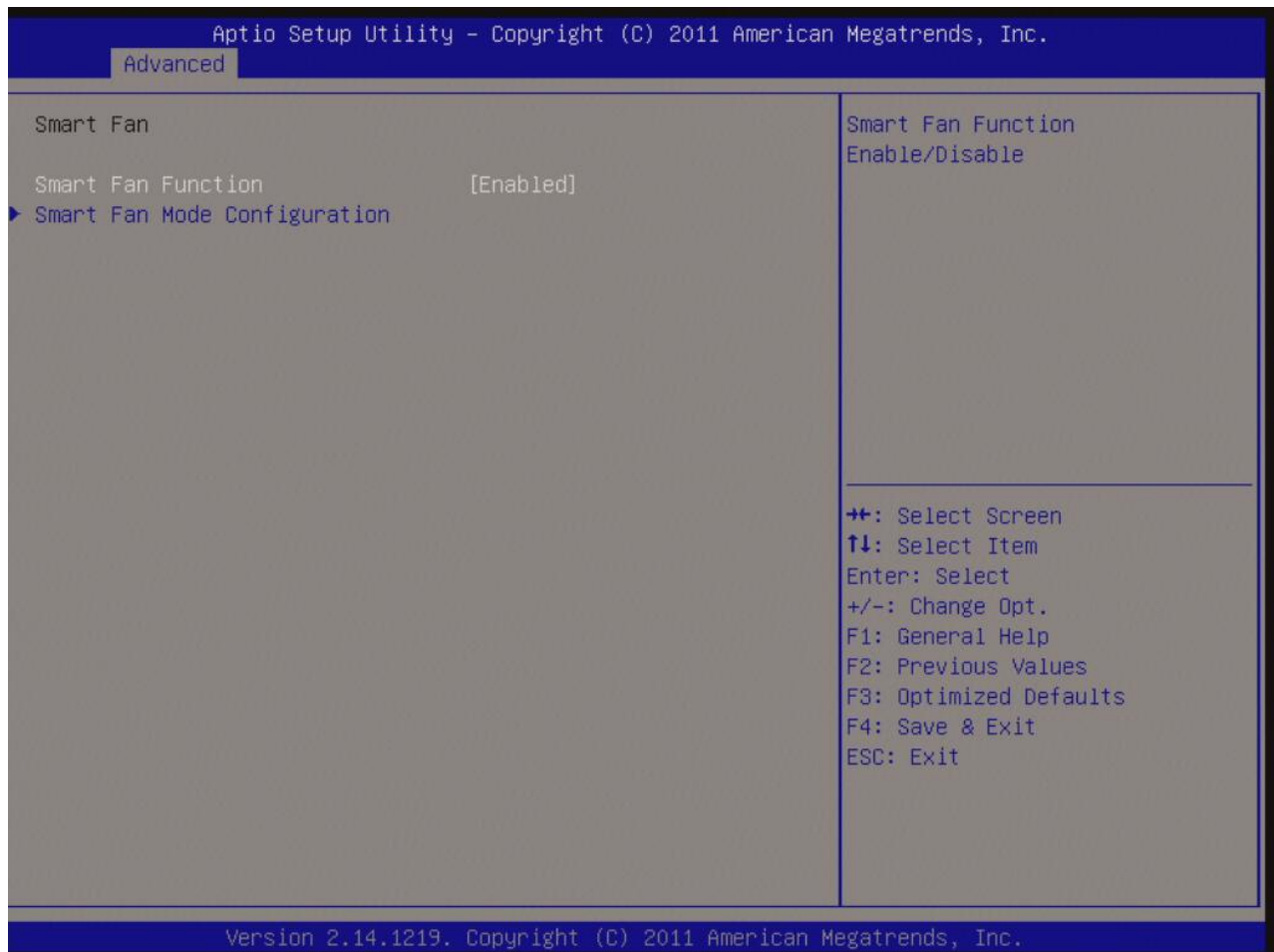

- **Smart Fan Function [Enabled]**

Configuration options: [Disabled], [Enabled]

3.6.11.2 Smart Fan Mode Configuration

Smart Fan Mode configuration

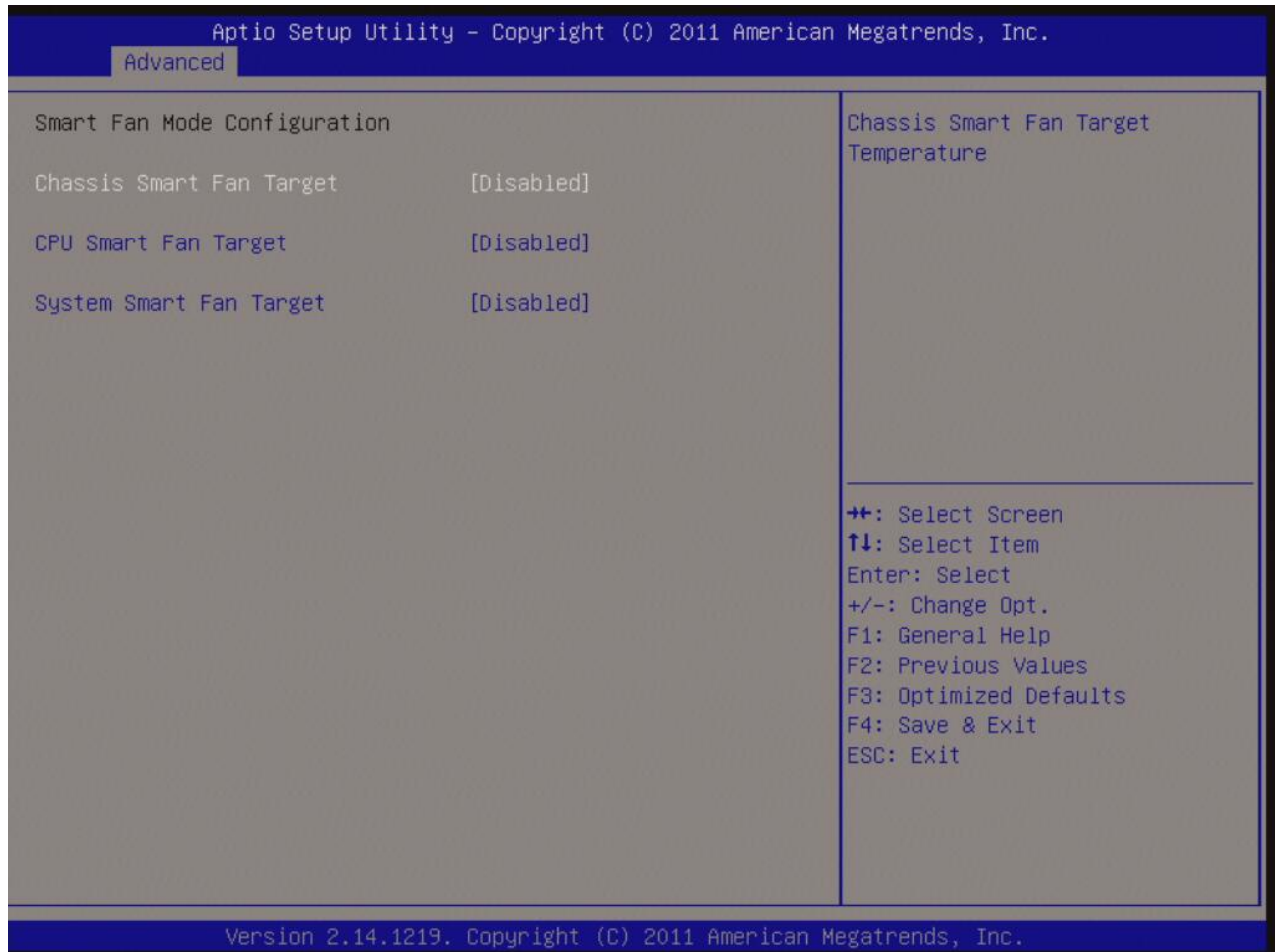

• Chassis Smart Fan Target [Disabled]

Select Chassis Smart Fan mode

Configuration options: [Disabled], [Enabled]

Once enabled, user may choose the desired % of minimum throttle output for the fan connected to Chassis Fan header.

Configuration options : [12.5%], [25%], [37.5%], [50%], [62.5%], [75%], [87.5%]

• CPU Smart Fan Target [Disabled]

Select CPU Smart Fan mode. Once enabled, user may choose the desired target temperature for CPU.

Configuration options: [Disabled], [40C], [45C], [50C], [55C], [60C], [65C], [70C]

- **System Smart Fan Target [Disabled]**

Select System Smart Fan mode

Configuration options: [Disabled], [Enabled]

Once enabled, user may choose the desired % of minimum throttle output for the fan connected to System Fan header.

Configuration options : [12.5%], [25%], [37.5%], [50%], [62.5%], [75%], [87.5%]

3.6.12 Option ROM Policy

Setup Option ROM related policy

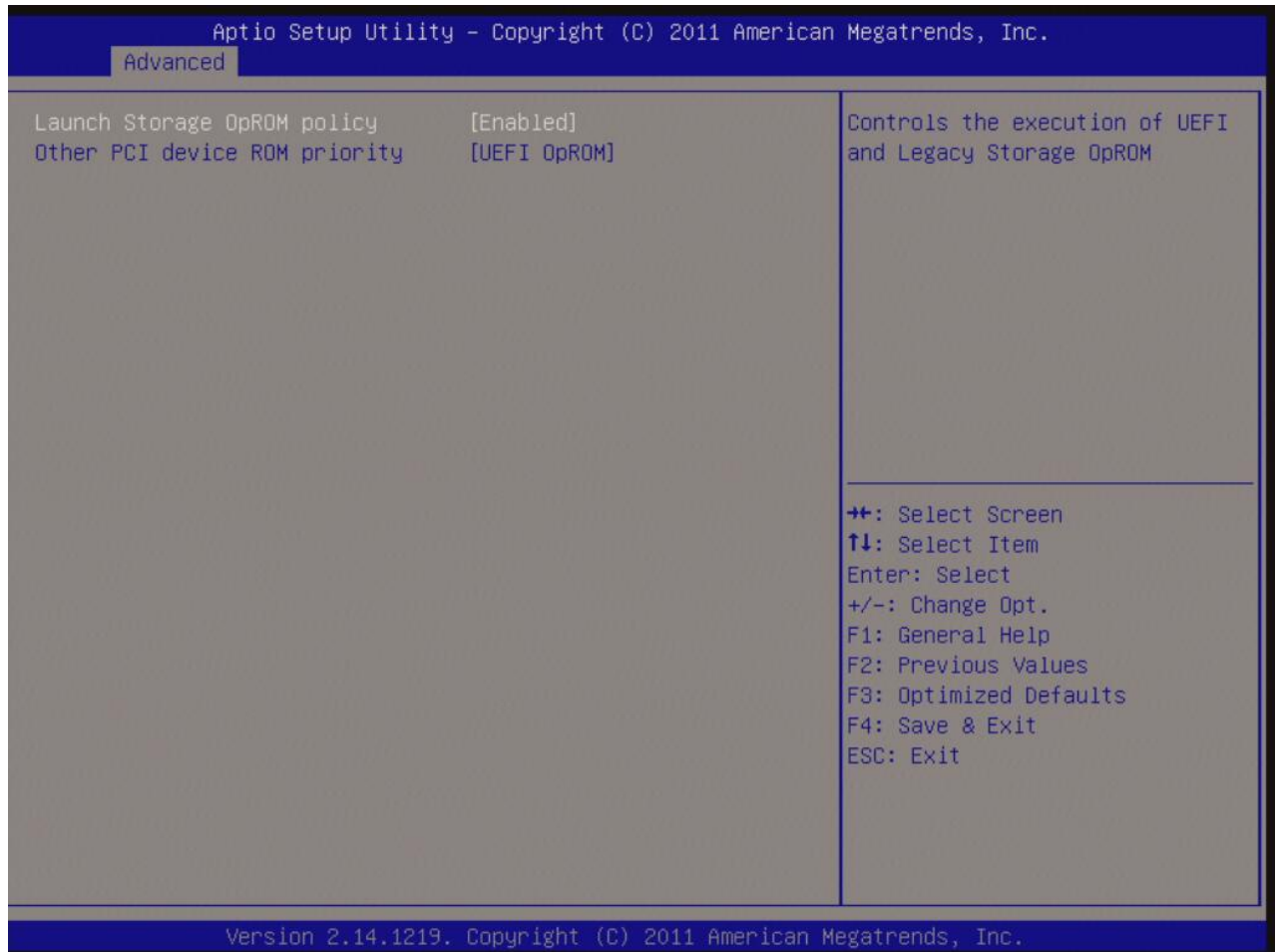

- **Launch Storage OpROM Policy [Enabled]**

Enable or Disable Boot Option For Legacy Mass Storage Devices with Option ROM

Configuration options: [Disabled], [Enabled]

- **Other PCI Device ROM priority [UEFI OpROM]**

Configuration options: [UEFI OpROM], [Legacy OpROM]

3.6.13 CPU PPM Configuration

Setup CPU related parameters

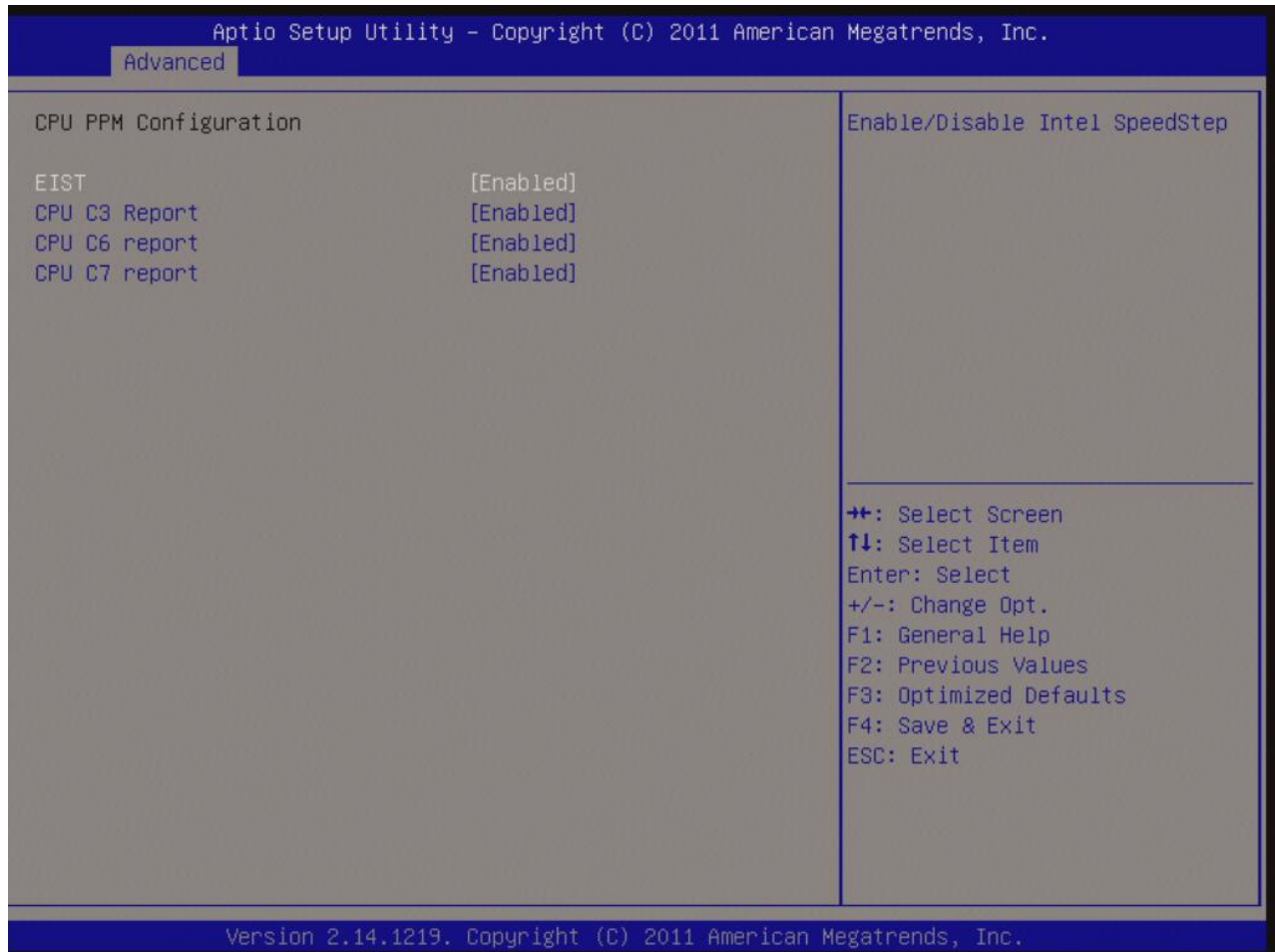

- **EIST [Enabled]**

Enable or disable speed step.

Configuration options: [Disabled], [Enabled]

- **CPU C3 State Support [Enabled]**

Use this to enable or disable CPU C3 (ACPI C2) report to OS.

Configuration options: [Disabled], [Enabled]

- **CPU C6 State Support [Enabled]**

Use this to enable or disable CPU C6 (ACPI C3) report to OS.

Configuration options: [Disabled], [Enabled]

- **CPU C7 State Support [Enabled]**

Use this to enable or disable CPU C7 report to OS.

Configuration options: [Disabled], [Enabled]

3.7 Chipset

Setup chipset related parameters

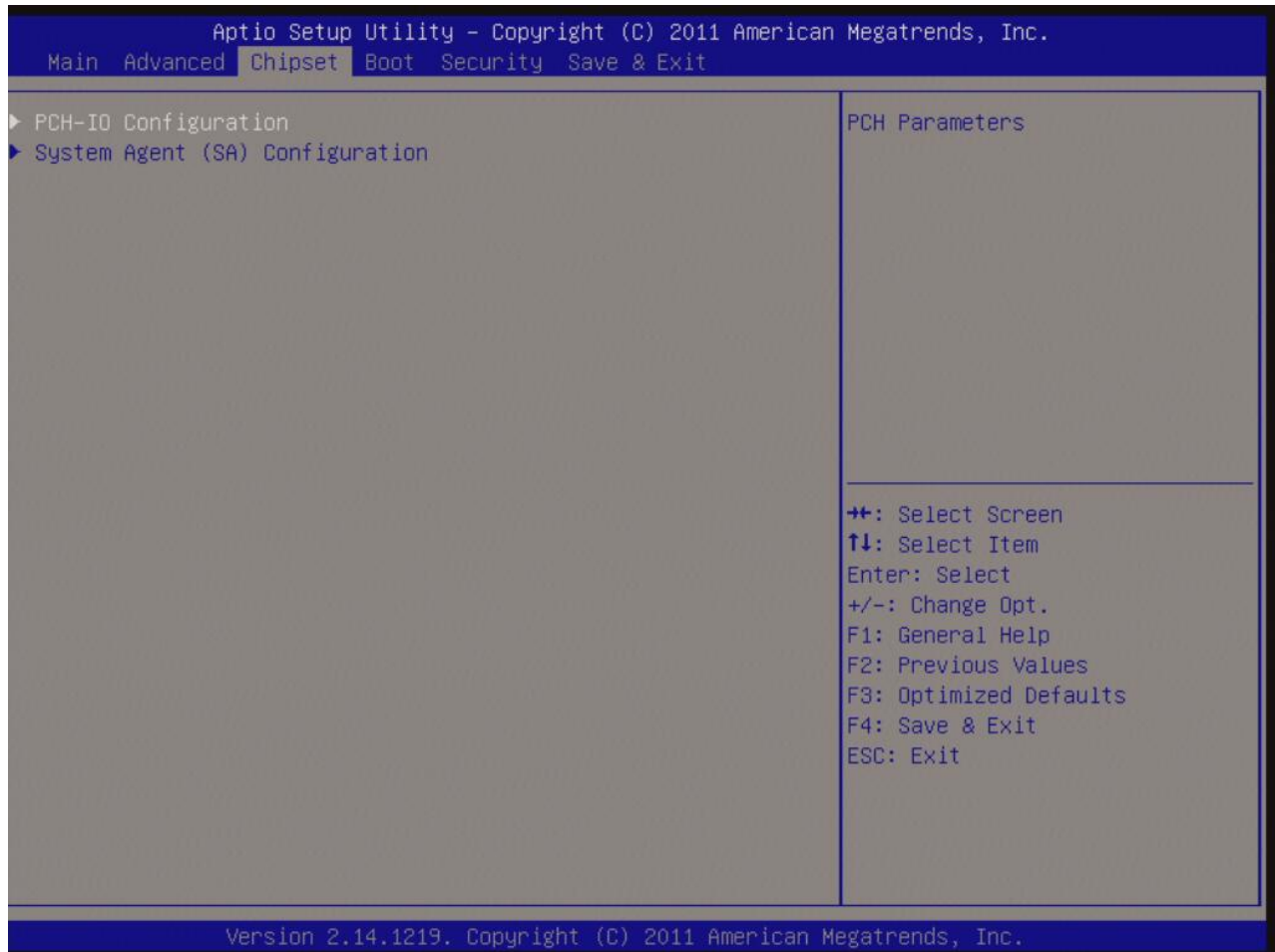

3.7.1 PCH-IO Configuration

Setup PCH-IO Configuration

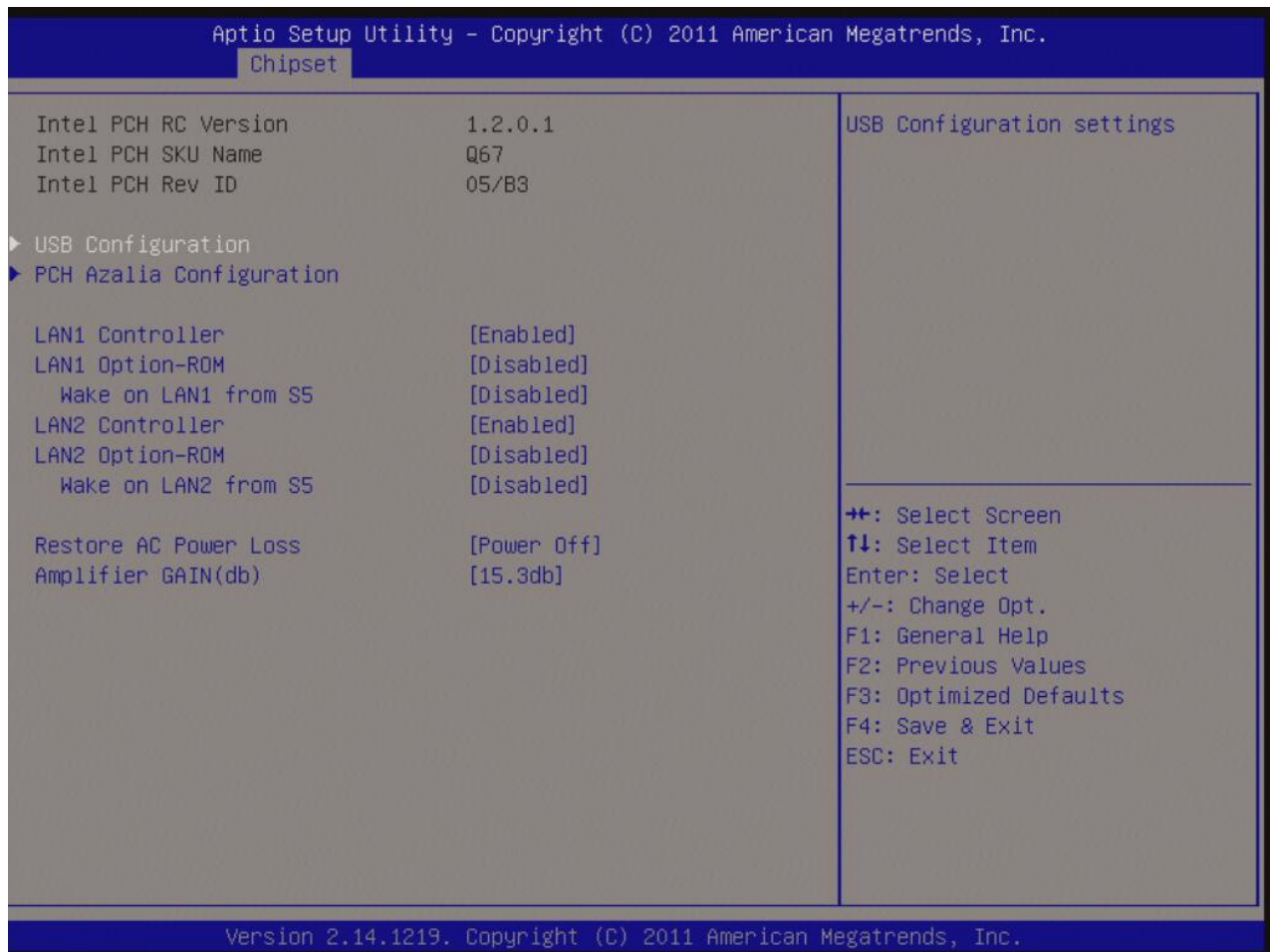

- **LAN1 Controller [Enable]**

Enable/Disable LAN1 Controller

Configuration options: [Disabled], [Enabled]

- **LAN1 Option-ROM [Disable]**

Enable/Disable LAN1 boot option for legacy network devices.

Configuration options: [Disabled], [Enabled]

- **Wake on LAN1 from S5 [Disable]**

Configuration options: [Disabled], [Enabled]

- **LAN2 Controller [Enable]**

Enable/Disable LAN1 Controller

Configuration options: [Disabled], [Enabled]

- **LAN2 Option-ROM [Disable]**

Enable/Disable LAN2 boot option for legacy network devices.

Configuration options: [Disabled], [Enabled]

- **Wake on LAN2 from S5 [Disable]**

Configuration options: [Disabled], [Enabled]

- **Restore AC Power Loss [Power Off]**

Specify what state to go to when power is re-applied after a power failure(G3 state).

Configuration options: [Power Off], [Power On], [Last state]

- **Amplifier Gain (db) [15.3db]**

Select the Amplifier Gain on header "JAMP1".

Configuration options: [15.3db], [21.2db], [27.2db], [31.8db]

3.7.2 USB Configuration

Setup USB related parameters

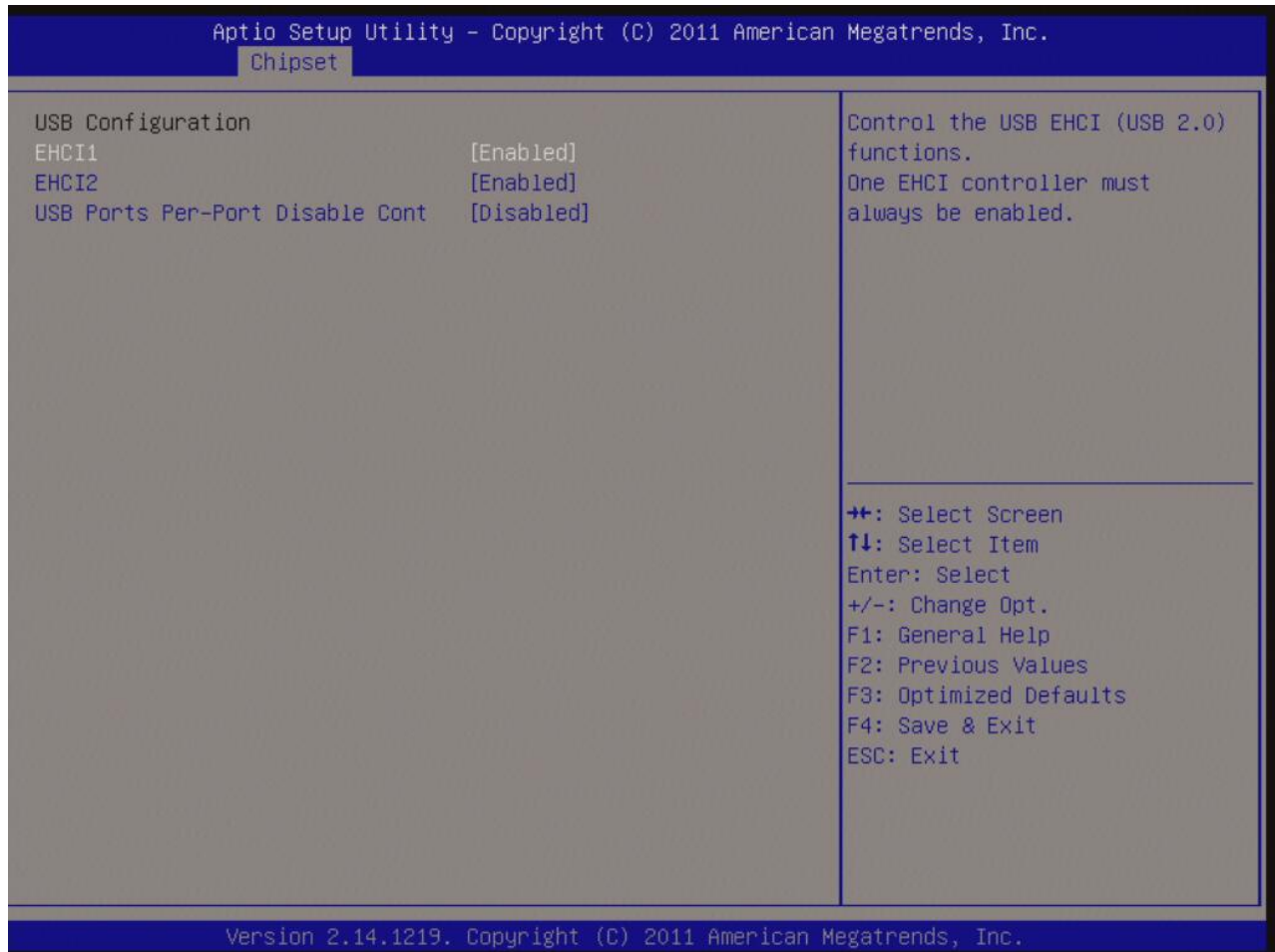

- **EHCI controller 1 [Enabled]**

Enable/Disable USB 2.0(EHCI) support

Configuration options: [Disabled], [Enabled]

- **EHCI controller 2 [Enabled]**

Enable/Disable USB 2.0(EHCI) support

Configuration options: [Disabled], [Enabled]

- **USB ports per-port disable cont [Disabled]**

Configuration options: [Disabled], [Enabled]

3.8 System Agent (SA) Configuration

System related parameters



- **VT-d [Enabled]**

Set VT-d Enable or Disable

Configuration options: [Enabled], [Disabled]

3.8.1 Graphics Configuration

Setup Graphic related parameters

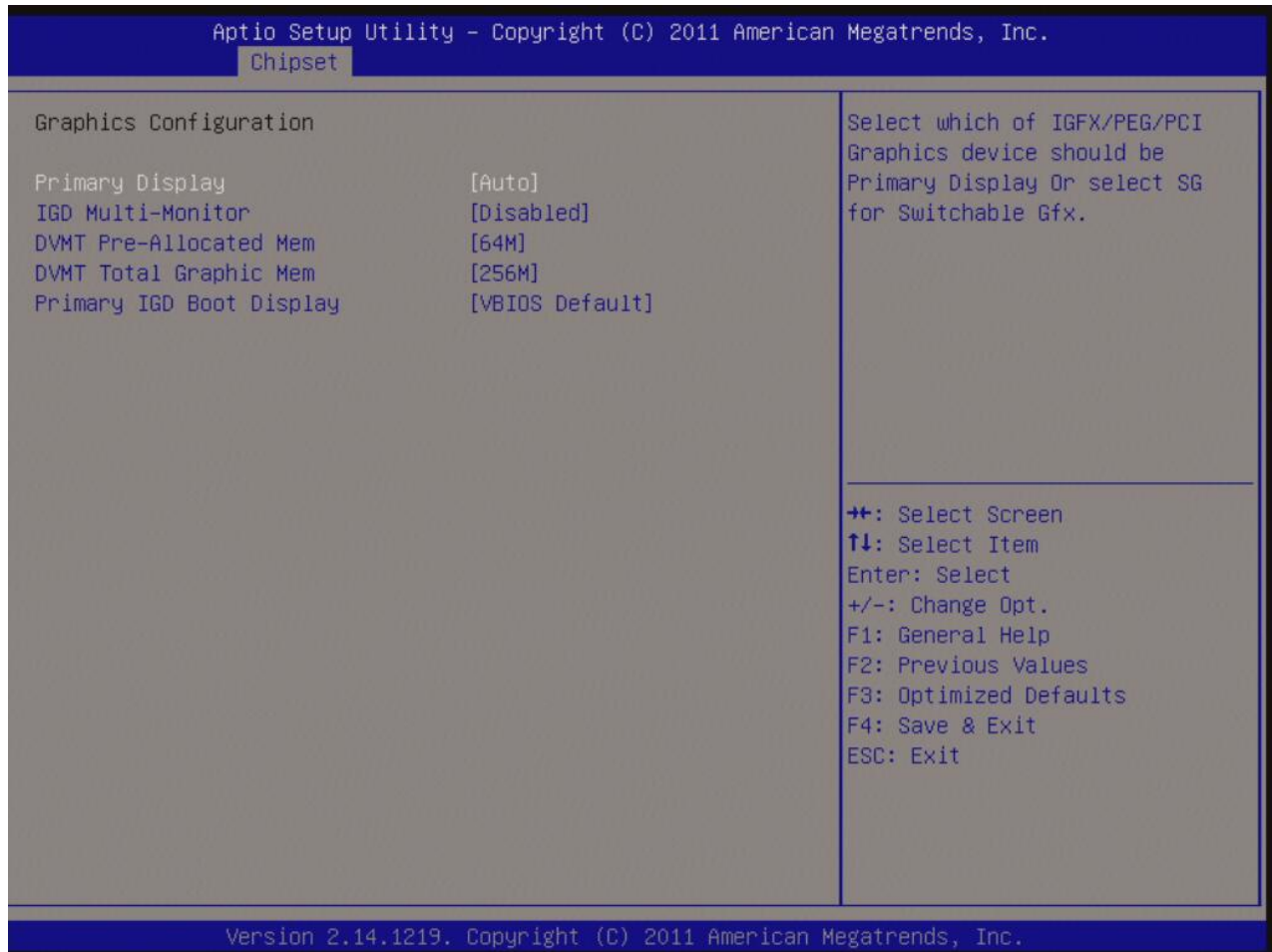

- **Primary Display [Auto]**

Select which graphics controller to use as the primary boot device.

Configuration options: [Auto], [IGD], [PEG], [PCI]

- **IGD Multi-Monitor [Disabled]**

Enable/Disable IGD Multi-Monitor by internal graphics device.

Configuration options: [Disabled], [Enabled]

- **DVMT Pre-Allocated Mem [64M]**

IGD shared memory size

Configuration options: [Disable], [32M], [64M], [96M], [128M], [160M], [192M], [224M], [256M], [288M], [320M], [352M], [384M], [416M], [448M], [480M], [512M]

- **DVMT Total Graphic Memory [128MB]**

Select DVMT/FIXED Mode Memory size used by Internal Graphic Device.

Configuration options: [128MB], [256MB], [Maximum]

- **Primary Display [VBIOS Default]**

If there are more than one display devices attached to the system, this option can select which display device will be activated during system post as primary display.

Configuration options: [VBIOS Default], [CRT], [DP1], [DVI], [DP2]

3.8.2 PCIe Configuration

PCI-E bus related parameters

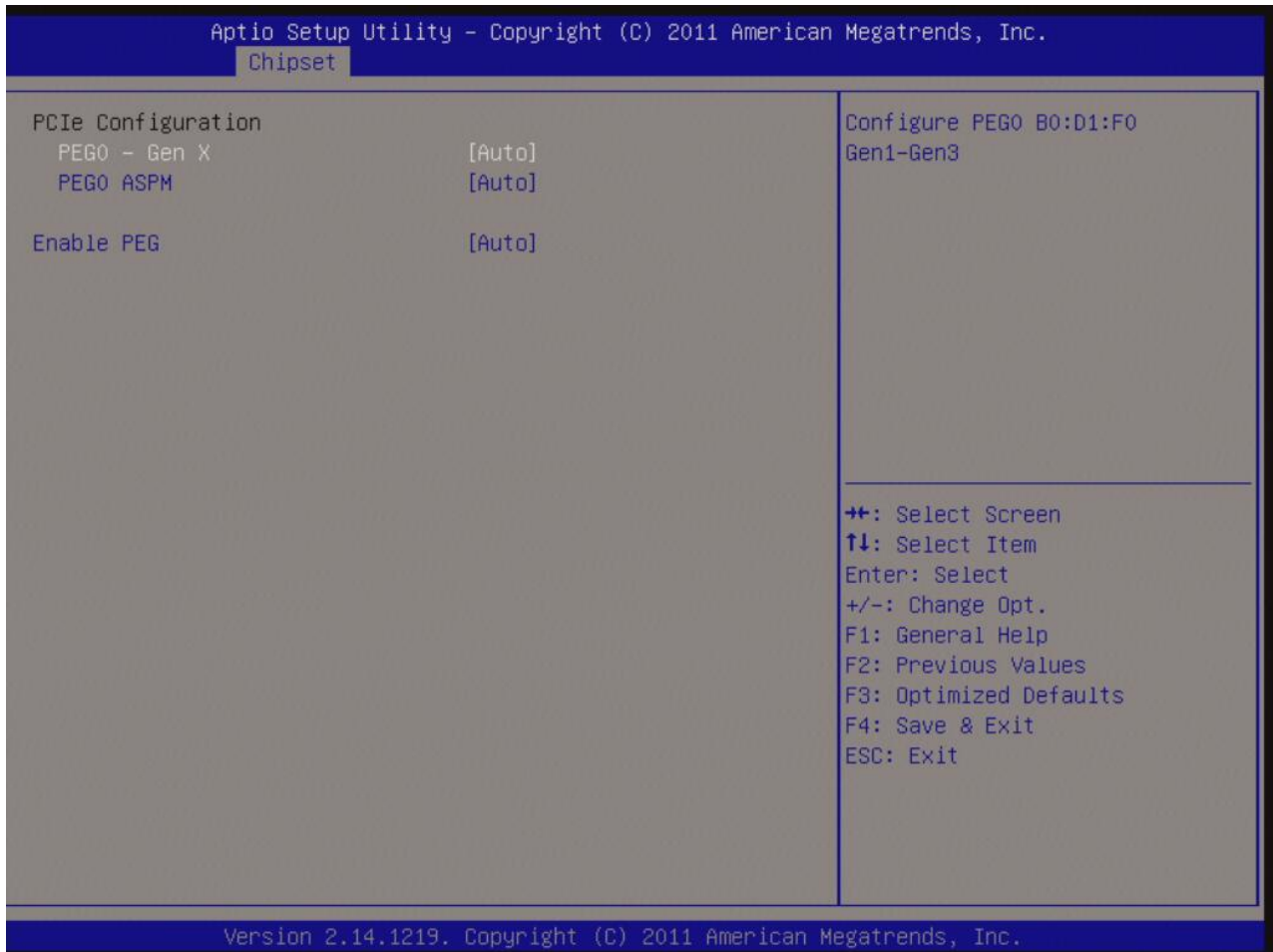

- **PEG0 – Gen X [Auto]**

Configure PEG0 B0 :D1 :F0 Gen1-Gen3.

Configuration options: [Auto], [Gen1], [Gen2], [Gen3]

- **PEG0 ASPM [Auto]**

Power management related feature ASPM, support for the PEG : Device 1 Function 0. This has no effect if PEG is not the currently active device.

Configuration options: [Auto], [Disabled], [ASPM L0s], [ASPM L1], [ASPM L0sL1]

- **Enable PEG [Auto]**

To enable or disable the PEG.

Configuration options: [Auto], [Disabled], [Enabled]

3.9 Boot

Setup boot related parameters

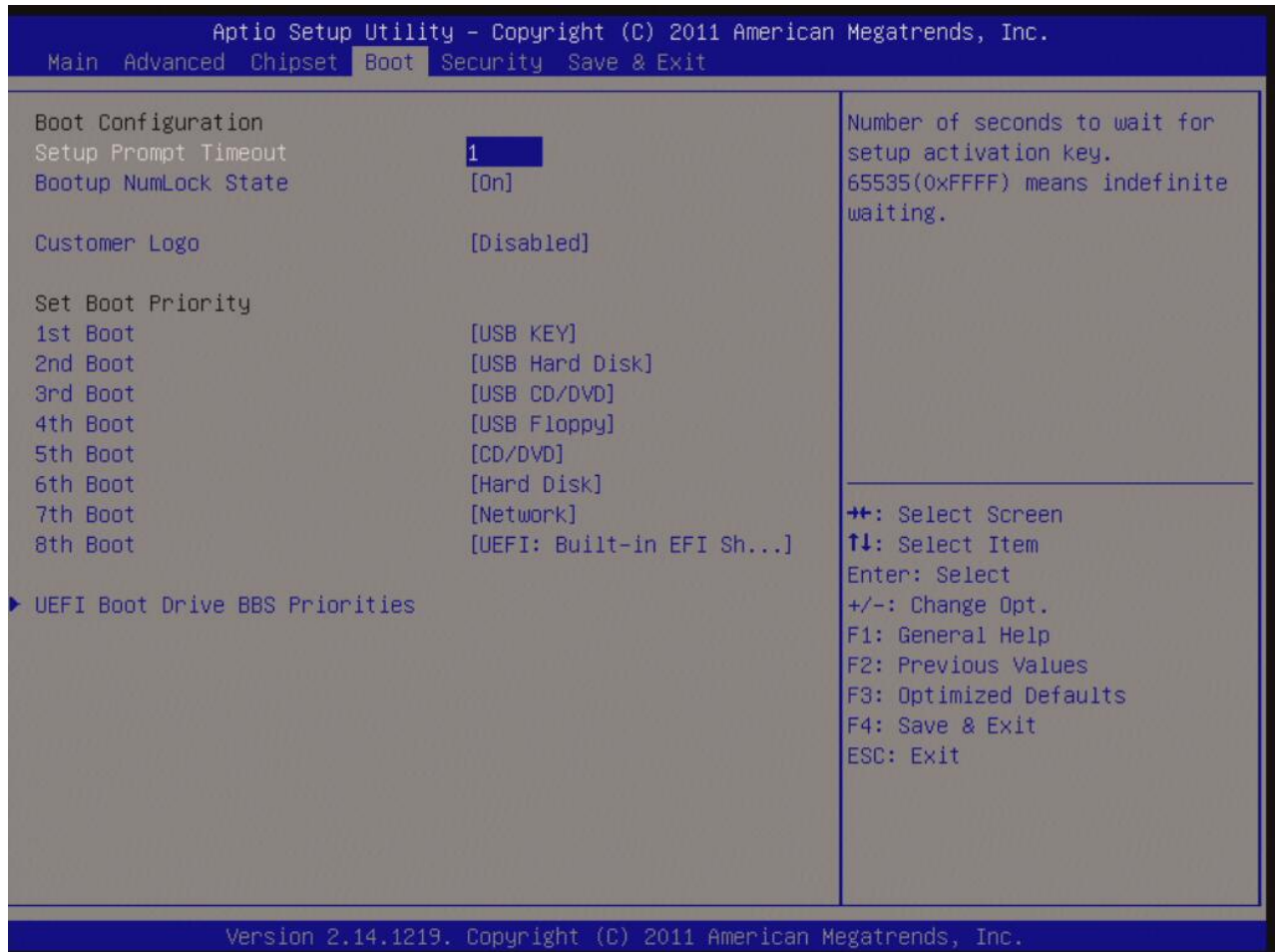

- **Setup Prompt Timeout [3]**

Number of seconds to wait during system post.

- **Bootup NumLock State [On]**

Select the keyboard NumLock state

Configuration options: [On], [Off]

- **Customer Logo [Disable]**

Display the custom added customer logo.

Configuration options: [Disable], [Enable]

3.9.1 UEFI Boot Drive BBS Priorities

Setup boot related parameter under UEFI category

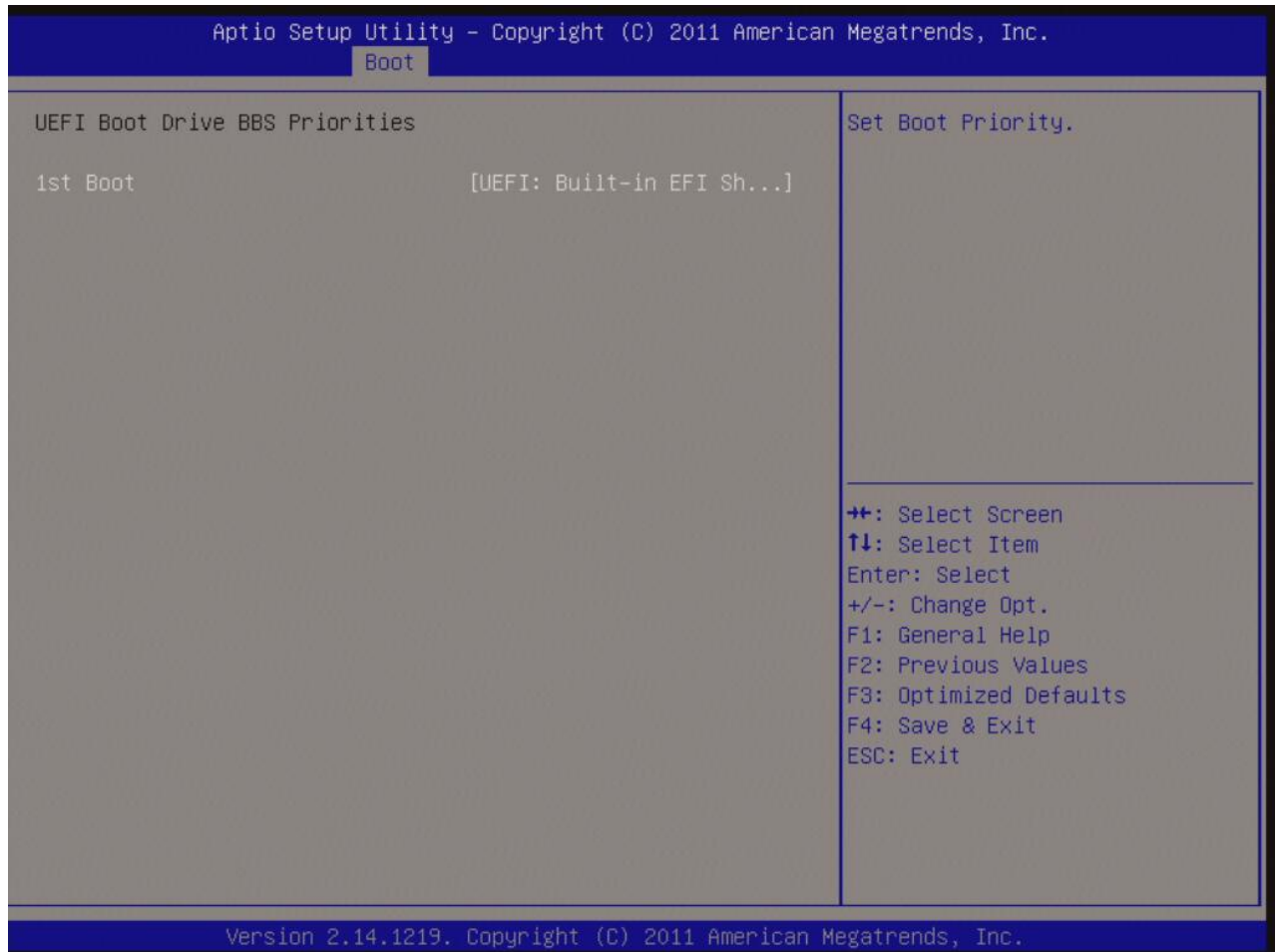

- **UEFI Boot Drive BBS Priorities**

Select the system boot order.

Configuration options: [Built-in EFI Shell], [Disabled]

3.10 Security

Setup the password

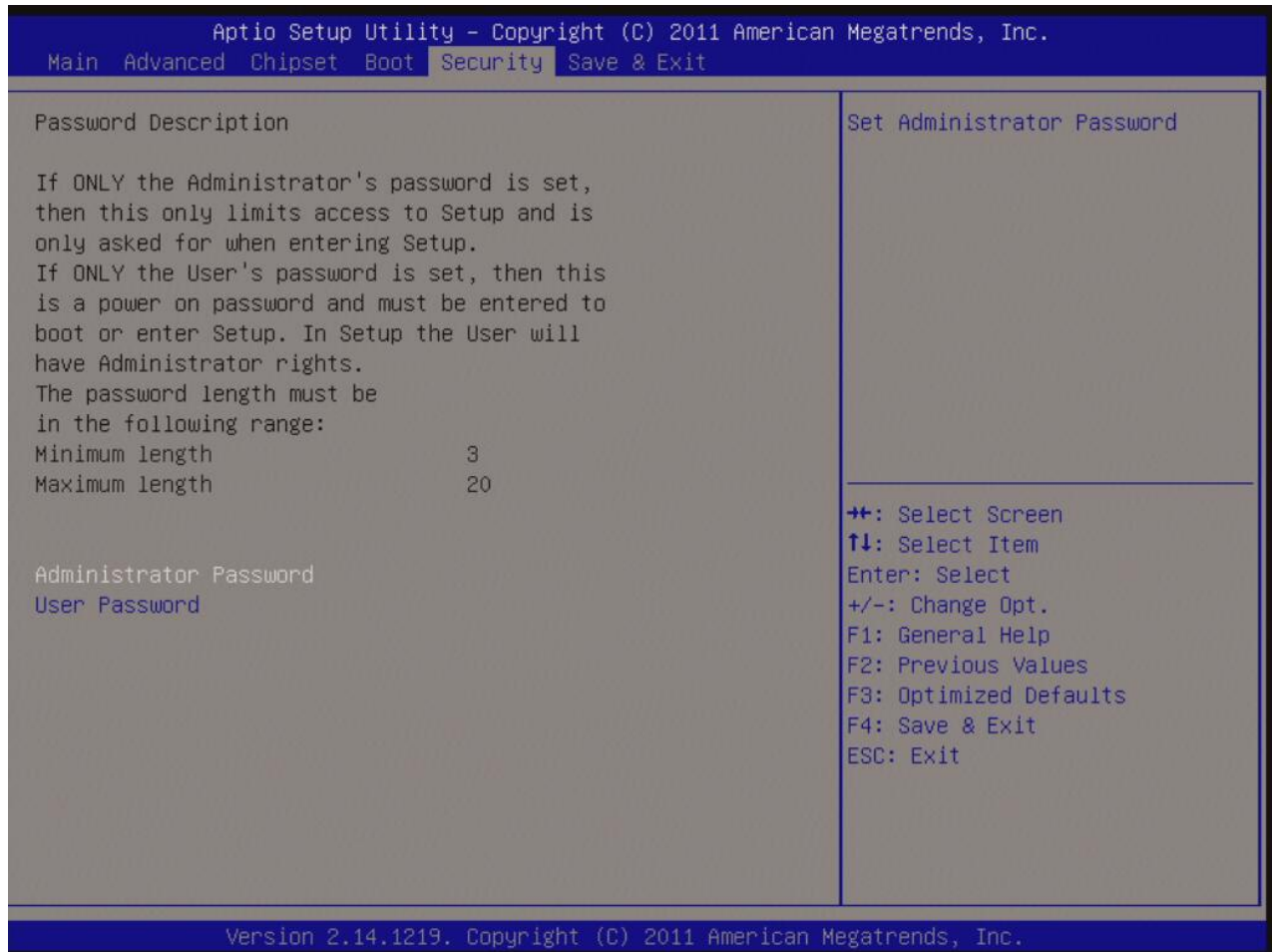

- **Administrator Password**

Set setup Administrator Password

- **User Password**

Set User Password

3.11 Save & Exit

Options for loading the optimized BIOS default ; and whether to save or discard the BIOS settings before leaving the BIOS menu.

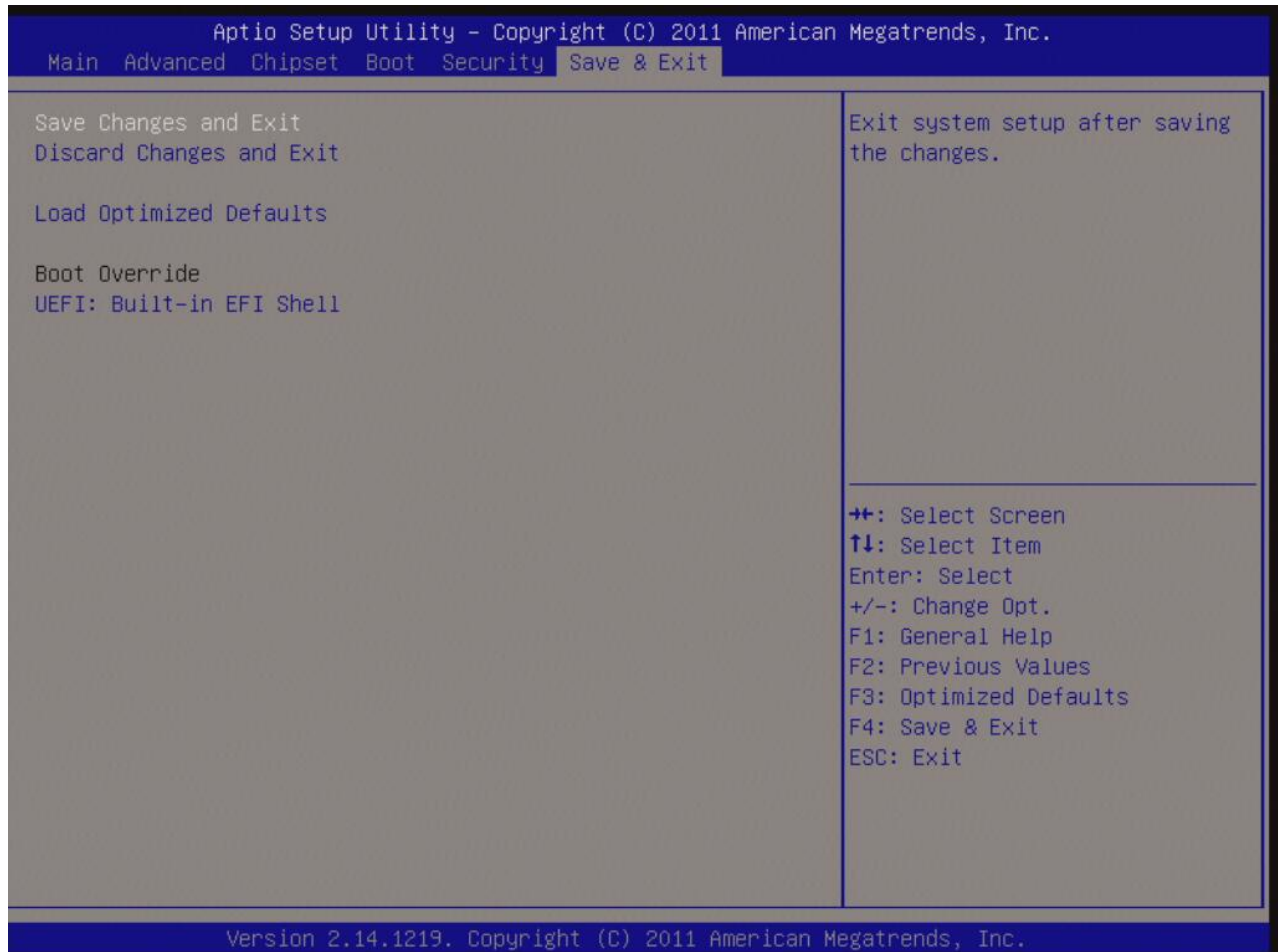

- **Save changes and Exit**

Exit system setup after saving the changes.

- **Discard changes and Exit**

Exit system setup without saving the changes.

- **Load Optimized Defaults**

Restore/Load default values for all the setup option.